For Ordering or Technical Information



Fisher Scientific

**For customer service, call 1-800-766-7000.
To fax an order, use 1-800-926-1166.
To order online: www.fishersci.com**



AccuSpin Micro 17 / 17R

Instructions for use



How to use this manual



Use this manual to get acquainted with your centrifuge and its accessories.

The manual helps you to avoid inappropriate handling. Make sure to keep it always close to the centrifuge.

A manual that is not kept available cannot provide protection against improper handling and thus against damage to persons and objects.

This manual comprises chapters on

- Safety regulations
- Instrument description
- Transportation and hook-up the centrifuge
- Rotor program and accessories
- Use of the centrifuge
- Maintenance and care
- Troubleshooting
- Technical data
- Index



- Align the notch below the rotor to the retaining pin of the drive shaft.
- Tighten the rotor integrated nut with the wrench provided. Check tight placement of the rotor regularly and re-tighten the rotor as needed.
- Ensure the lid clicks loudly before each use.

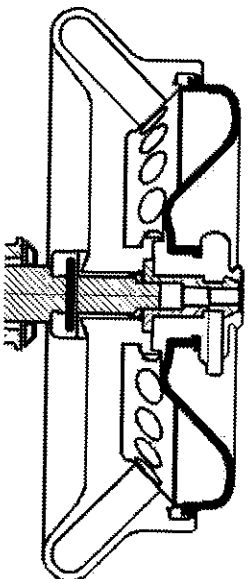

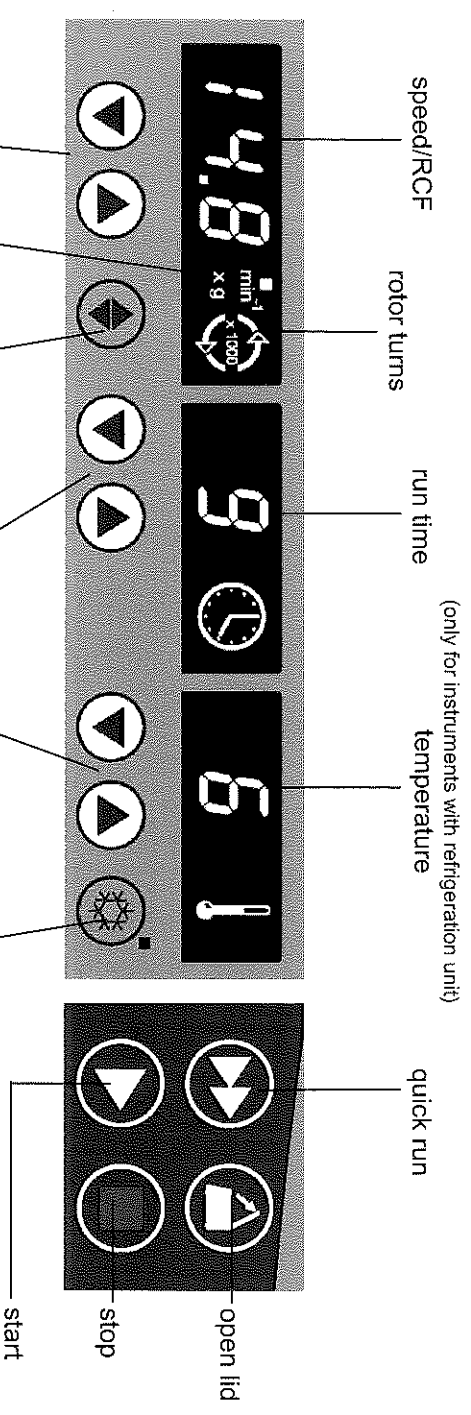

 Note that "min⁻¹" stands for "rpm" and "x g" stands for "RCF"

 Before switching on the centrifuge please read this manual!

Control panel

Display panels

Speed / RCF

Resting state:

current value (0) or pre-selected set-point value
present current value of speed or RCF
(after activation of switch key)

During run:

Circulating light-points:
rotor turns

End:

„End“

Error codes:
flashing display with error code

Run time

Resting/End:

current value (0) / „End“, or pre-selected set
point value
(in minutes, or „hd“ for permanent operation)

Time selection/run: - remaining time till „0“ in minutes

Permanent operation (hd): - run time passed in seconds/ minutes

„Quick run“: - run time passed in seconds/ minutes

Temperature*

according to:

current sample temperature in °C
(in temperature equilibrium)

* only for instruments with refrigeration unit

Keys

start:

start of the centrifuge

stop:

manually stop of a run

open lid:

open lid
(possible only with the instrument switched on and
standstill of the rotor)

quick run:

short-term run up of the centrifuge as long as key
remains pressed

Switch

Speed/RCF:

switching between speed and RCF display

Pre-temp:

pre-temp-function*

„set“ keys:

stepwise increase/decrease of set-point values

Short pressing of any of the "set" keys:

switch from current to pre-selected set-point value, signaled by
flashing display.

(Error codes (see „troubleshooting“section):

E-14: over temperature centrifuge chamber (> 50 °C)

E-22: troubled speed measurement

E-24: lid will not open

E-31: over temperature motor

E-36: over amperage or over voltage

E-46: lid was opened manually during run

E-57: imbalance

E-60: under temperature centrifuge chamber (< -20 °C)

Contents

For your safety	3	Operation without rotor lid	18
Safety instructions in this manual	3	Rotor lid with screw plug	19
Proper use	4	Aerosol-tight application.....	20
Improper use	4	Checking for aerosol-tightness.....	22
Centrifuging hazardous materials	4	Operation	23
Handling the centrifuge	4	Switching on the centrifuge	23
Conformity to current standards.....	5	Opening the lid	23
Description of the instrument	7	Closing the lid.....	23
Pieces delivered	7	Installing the rotor.....	24
Safety systems.....	7	Loading the rotor	26
Properties	8	Maximum load	26
Before use	9	Filling the centrifuge tubes	26
Where to install the centrifuge	9	Placing the tubes in the rotor.....	27
Transport and installation the centrifuge.....	9	Entering parameters.....	28
Centrifuge with refrigeration unit	9	Switching from speed to RCF display.....	28
Mains connection	10	Selecting speed.....	28
Removing the transport protection.....	10	Entering the RCF value.....	29
Accessories	11	Concerning the RCF value	29
Rotors for the accuSpin Micro 17.....	12	Selecting the run time	30
Rotors for the accuSpin Micro 17R.....	14	Run time selection.....	30
Adapter.....	16	Continuous operation	30
Handling the rotor	17	Setting the temperature.....	31
Rotor lid with a spring lock	17	Pretemp	32
		Starting the centrifuge	33
		Changing the settings during the run	33

Stopping the centrifuge	34	Speed/RCF diagram.....	60
Preset run time	34	Autoclaving protocol.....	66
Continuous operation	34	Index	69
Short-time centrifugation	34		
Removing the rotor.....	35		
Audible alarm	35		
Turning off the centrifuge	36		
WEEE Compliance:.....	36		
Maintenance and care	37		
Maintenance to be performed by the customer	37		
Cleaning.....	37		
Cleaning the filter unit.....	38		
Disinfection	39		
Decontamination.....	41		
Autoclaving	41		
Troubleshooting	43		
Mechanical emergency lid release.....	43		
Problems you can handle yourself.....	45		
Contacting Service	51		
Technical data.....	53		
Component parts.....	53		
The "Easycontrol" user interface.....	54		
Performance	55		
Electrical connections.....	57		
Appendix	59		

For your safety

Safety instructions in this manual



This symbol denotes potential hazards to persons.



This symbol denotes potential damage to the centrifuge or parts in its immediate surroundings.



Warning: hot surfaces



General danger area
Before switching on the centrifuge please read this manual!



General hints are marked with this symbol.

Fisher Scientific® centrifuges are manufactured according to current technical standards and regulations. Nonetheless, centrifuges may pose danger to individuals and surrounding if

- they are not used as designed
- they are operated by untrained personnel
- their design is improperly changed
- the safety instructions are not followed



Therefore, personnel involved with operation and maintenance of the centrifuge must read and follow the safety instructions.

In addition, the pertinent regulations for prevention of accidents must be strictly followed.

This manual is an integral part of the centrifuge assembly and must be kept close at hand at all times.



When damages to the power cord or at casing are noticed the centrifuge must be set out of operation!

Proper use

The centrifuge is designed to separate liquid-suspended materials having different densities and particle size (maximum sample density is 1.2 g/cm³ at maximum speed).

Improper use

During a run, a safety zone of 30 cm around the centrifuge must be maintained where neither persons nor hazardous materials may be present.

The centrifuge may cause harm to its user or other persons or may damage goods if safety measures are not followed:

Centrifuging hazardous materials

- The centrifuge is neither made inert, nor is it explosion-proof. Therefore never use the centrifuge in an explosion-prone environment.
- Do not centrifuge explosive or flammable substances. The same holds for substances prone to react violently with each other.
- Do not centrifuge toxic or radioactive substances or pathogenic micro-organisms without suitable safety systems.
If microbiological samples of risk group II (according to "Laboratory Bio-safety Manual" of WHO) are

being centrifuged, aerosol-tight bio-seals have to be used.

For materials in a higher risk group, more than one precaution is required.

- Should toxins or pathogenic substances enter the centrifuge or its parts, you must perform appropriate procedures for disinfection (see "Maintenance and care – Disinfection").
- Strongly corrosive substances that may cause damage to materials and reduce the mechanical strength of the rotor may be centrifuged only inside protective tubes.

Handling the centrifuge

- Use only original accessories for the centrifuge. The only exceptions are common glass or plastic centrifuge tubes if they are approved for the rotor speed and RCF values.
- Never use the centrifuge unless the rotor is properly installed.
- You may use the centrifuge only with a properly loaded rotor. You must not overload the rotor.
- Strictly follow the rules and regulations for cleaning and disinfection.
- If the rotor or the rotor lid shows signs of corrosion or wear, you must stop using it.

- Never open the lid manually if the rotor is still turning.
- You may use the emergency lid release only in case of emergency, e.g. during an interruption of power supply (see chapter "Troubleshooting").
- Never use the centrifuge with an opened lid.
- Never use the centrifuge if the front panel has been partially or totally removed.
- Changes in mechanical or electrical components of the centrifuge may only be carried out by individuals authorized by Fisher Scientific®.

Conformity to current standards

Fisher Scientific® centrifuges are manufactured and tested according to the following standards and regulations

- for all voltages

- IEC 61010-1
IEC 61010-2-020

- for 120 V only



- for 230 V only



Please get acquainted with the details of the test standards from the technical data

For your safety

for your notes

Description of the instrument

The descriptions apply generally for all instrument variants.



Pieces delivered

- Micro-liter-rotor 24 x 1,5 / 2 ml 75003524
- a special wrench for securing the rotor
- cable for mains connection
- this Manual



Safety systems

The accuSpin Micro 17 and the accuSpin Micro 17R are equipped with several safety measures:

- Housing made of highly impact-resistant plastic; Extra steel armor.
- Lid with window and lid latch with locking mechanism
You can open the centrifuge lid only when the centrifuge is switched on and the rotor is standing. You can only start the centrifuge if the lid is properly locked.
- Lid emergency release: Only in case of emergency, e.g. the power supply is interrupted.

(see chapter „troubleshooting“)







Do not tamper with the safety systems!

Properties

The accuSpin Micro 17 and the accuSpin Micro 17R are tabletop centrifuges designed for the use in biochemical and medical laboratories.

The preset speed is reached in seconds. You can also spin samples for only a few seconds using the "quick run" key () if this is required for the task in question. The extremely long-lived, maintenance-free induction motor provides quiet and vibration-free operation even at high speeds.

The user-friendly user interface „Easy control“ permits easy handling. Prior to the run, when the centrifuge is switched on and the lid is closed, the current values are displayed and the pre-selected set point value can be set. While the centrifuge is operating, the display informs of current values or (by quickly pressing one of the "set" keys  or ) the pre-selected set point values for speed/RCF and runtime, as well as temperature in the refrigerated units. After the run, the speed control panel displays "End".

If you press one of the keys  or  repeatedly, you increase or decrease the corresponding pre-selected set point value stepwise. If you press the chosen key and hold it pressed, the respective chosen measurement value increases or decreases continuously, at first slowly and, after a few seconds, at an accelerated pace.

You can change the set values during operation.

"Quick run" operation

As long as the "quick run" key () is pressed, the rotor is accelerated with maximum power (potentially up to the maximum speed).

Before use

Where to install the centrifuge

The centrifuge may only be used indoors. Its location must meet the following criteria:

- A safety zone of 30 cm around the centrifuge must be maintained. Hazardous materials must not be kept within this zone during centrifugation.
- The substructure must be stable and resonance-free. A good support is provided by a plane laboratory bench or a large laboratory carriage with casters that may be locked.
- In the area of 15 cm around the centrifuge a sufficient air circulation has to be ensured.
- The centrifuge must be protected from heat and direct sunshine. The ultraviolet radiation may damage the housing.
- The installation site should be always well ventilated.

Transport and installation the centrifuge



Transport the centrifuge only in the upright position, using the special box provided with the instrument, and secure it properly.

Place the centrifuge carefully to avoid damages.



Lift up the instrument only on the bottom plate. Mind the weight of the centrifuge during the transport!
(See „Technical data“)

Let someone assist you in carrying the centrifuge!

Centrifuge with refrigeration unit



In order to allow the coolant to settle down in the compressor, the instrument must be left idle at the new location for approx. 1 hour.

Mains connection

Make sure that the mains supply and the frequency meet the specifications printed on the centrifuge type plate.

First turn the mains switch of the centrifuge off (press "0") and only then connect the centrifuge with the mains supply using the power cord supplied.

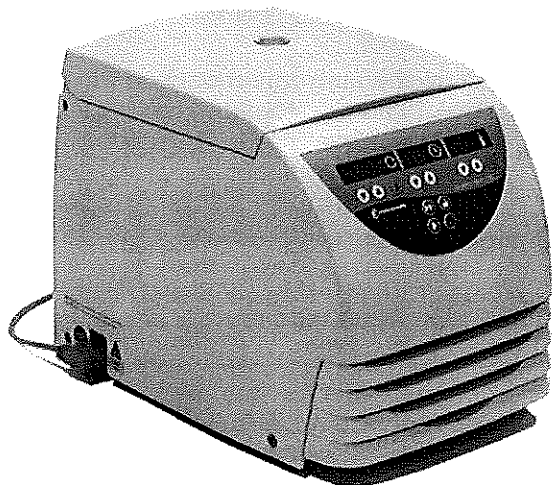

Removing the transport protection



Before using the centrifuge, make sure that the rotor transport protection has been removed!

Turn the instrument on at the power switch. Open the centrifuge lid by pressing the "open lid" key  and remove the transport protection for the rotor.

Check the free run of the rotor body by lightly turning it, and make sure the rotor is tightly screwed and the rotor lid is securely mounted.

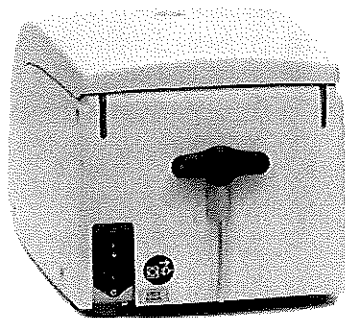

Accessories

The centrifuge is delivered complete with a fixed-angle rotor with 24 holes for placing Micro liter tubes with a volume of 1.5 or 2.0 ml.

In addition you may order three sets of adapters containing 24 reduction sleeves each. With these adapters you can centrifuge all commercially available Micro liter tubes with a volume between 0.2 and 0.6 ml as well as 0.2-ml PCR reaction vessels.

Wide range of various additional rotors is available.

Please consult our sales documentation for a complete collection of accessories including technical data and order numbers.

For more information you can visit our web site at <http://www.fishersci.com>



Rotors for the accuSpin Micro 17

<i>Table 1: Performance characteristics for accuSpin Micro 17</i>			
rotor designation	Micro liter-rotor 24 x 2 ml	Micro liter-rotor 36 x 0,5 ml	Dual-rotor 18 x 2 ml / 0,5 ml
order no.	75003524	75003436	75003418
places / volume	24 x 1.5 / 2 ml	36 x 0.5 ml	18 x 2 ml + 18 x 0.5 ml
maximum permissible load [g]	24 x 4	36 x 0.5	18 x 4 + 18 x 0.5
minimum speed n_{min} [min^{-1}]	300	300	300
maximum speed n_{max} [min^{-1}]	13 300	13 300	13 300
maximum RCF value at n_{max}	17 000	15 600	16 800
acceleration / deceleration time [s]	11/12	9/10	11/12
radius maximum/ minimum [cm]	8.6 / 5.1	7.9 / 5.0	8.5 / 4.8
angle [°]	45	45	45
heating of samples at n_{max} [°C] relative to room temperature 23°C, run time 1 hour	33	31	33
aerosol-tight *	yes	no	no
permissible temperature range autoclavable (number of cycles)	-4 °C to +40 °C 121°C, (20 cycles)	-4 °C to +40 °C 121°C, (20 cycles)	-4 °C to +40 °C 121°C, (20 cycles)

* Tested and approved by HPA, Porton-Down, UK – Please see the references in the chapter "Aerosolight application"!

Table 1: Performance characteristics for accuSpin Micro 17

rotor designation	PCR-rotor 4 x 8	PCR-rotor 8 x 8	Haematocrit-rotor
order no.	75003434	75003489	75003473
places / volume	4 x PCR-Strip	8 x PCR-Strip	24 x Blood capillary tubes 75 mm
maximum permissible load [g]	4 x 4 (32 x 0,5)	8 x 4 (64 x 0,5)	24 x 0,2
minimum speed n_{min} [min^{-1}]	300	300	300
maximum speed n_{max} [min^{-1}]	13 300	13 300	13 300
maximum RCF value at n_{max}	13 100	13 800	16 800
acceleration / deceleration time [s]	10 / 11	7 / 8	10 / 11
radius maximum / minimum [cm]	6,6 / 4,7	7,0 / 4,4	2,0 / 8,5
angle [°]	45	60	90
heating of samples at n_{max} [°C] relative to room temperature 23°C, run time 1 hour	31	31	34
aerosol-tight *	yes	no	no
permissible temperature range autoclavable (number of cycles)	-4 °C to +40 °C 121°C, (20 cycles)	-4 °C to +40 °C 121°C, (20 cycles)	-4 °C to +40 °C 134°C

* Tested and approved by HPA, Porton-Down, UK -- Please see the references in the chapter "Aerosol-tight application"!

Rotors for the accuSpin Micro 17R

Table 3: Performance characteristics for accuSpin Micro17R differences of 120V instruments are shown in parentheses

rotor designation	Microliter-rotor 24 x 2 ml	Microliter-rotor 36 x 0,5 ml	Dual-rotor 18 x 2 ml / 0,5 ml
order no.	75003524	75003436	75003418
places / volume	24 x 1,5 / 2 ml	36 x 0,5 ml	18 x 2 ml + 18 x 0,5 ml
maximum permissible load [g]	24 x 4	36 x 0,5	18 x 4 + 18 x 0,5
minimum speed n_{min} [min^{-1}]	300	300	300
maximum speed n_{max} [min^{-1}]	13 300	13 300	13 300
maximum RCF value at n_{max}	17 000	15 600	16 800
acceleration / deceleration time [s]	10 / 12	8 / 10	10 / 12
radius maximum / minimum [cm]	8,6 / 5,1	7,9 / 5,0	8,5 / 4,8
angle [°]	45	45	45
minimum temperature at n_{max} [°C] relative to room temperature 23°C	≤ 0	≤ 0	≤ 0
aerosol-tight *	yes	no	no
permissible temperature range autoclavable (number of cycles)	-4 °C to +40 °C 121°C, (20 cycles)	-4 °C to +40 °C 121°C, (20 cycles)	-4 °C to +40 °C 121°C, (20 cycles)

* Tested and approved by HPA, Porton-Down, UK – Please see the references in the chapter "Aerosoltight application"!

Table 3: Performance characteristics for *accuSpin Micro 17R*

rotor designation order no.	PCR-rotor 4 x 8 75003440	PCR-rotor 8 x 8 75003489	Haematocrit-rotor 75003473
places / volume	4 x PCR-Strip	8 x PCR-Strip	24 x Blood capillary tubes 75 mm
maximum permissible load [g]	4 x 4	8 x 4	24 x 0,2
minimum speed n_{min} [min^{-1}]	300		300
maximum speed n_{max} [min^{-1}]	13 300	13 300	13 300
maximum RCF value at n_{max}	13 100	13 800	16 800
acceleration / deceleration time [s]	9 / 12	6 / 8	9 / 11
radius maximum / minimum [cm]	6,6 / 4,7	7,0 / 4,4	2,0 / 8,5
angle [°]	45	60	90
minimum temperature at n_{max} [°C] relative to room temperature 23°C	≤ 0	≤ 0	≤ 0
aerosol-tight *	yes	no	no
permissible temperature range autoclavable (number of cycles)	-4 °C to +40 °C 121°C, (20 cycles)	-4 °C to +40 °C 121°C, (20 cycles)	-4 °C to +40 °C 134°C

* Tested and approved by HPA, Porton-Down, UK – Please see the references in the chapter "Aerosol-tight application"!

Adapter

adapter for Micro liter rotor 7500 3424	max. tube dimensions d ¹⁾ x length [mm]	tube capacity [ml]	number per set	color	no. of order
reduction sleeve PCR		0,2	24	grey	7600 3750
reduction sleeve		0,5 / 0,6	24	turquoise	7600 3758
reduction sleeve		0,25 / 0,4	24	red	7600 3759

Handling the rotor

Rotor temperature



The rotors are only to be used within the temperature range from -9°C to +40°C. Pre-tempering in a freezer below -9°C is forbidden.

Lifetime of the rotor

There is no limitation on the service life of the high performance rotors. However please observe the following due to safety reasons:



Rotors and accessories made of plastic should not be exposed to direct sunlight and UV radiations.

If the rotor shows signs of discoloration, deformation or wear, or imbalance it has to be exchanged straight away!

Rotor lid with a spring lock

Opening

The rotor lid is held on the central rotor nut integrated into the rotor

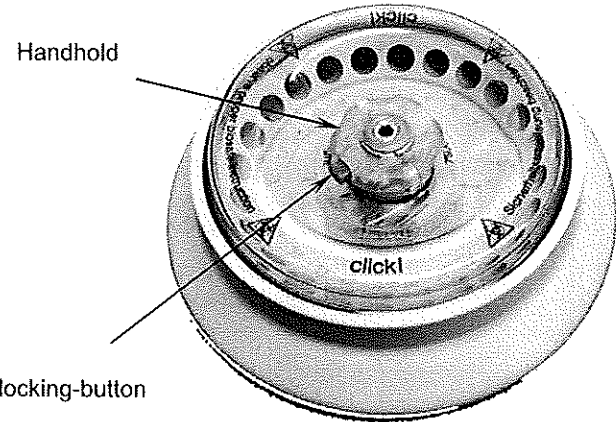

The rotor lid is opened by pressing the red unlocking-button in the central handhold of the rotor lid.

The lid can be lift-off easy.

- Closing

For closing the rotor place the rotor lid centrally on the rotor nut.

Press the rotor lid down now until the lock is audiovisually locked

If the lid will not lock or it locks only with difficulty, the seals should be checked for proper fit and fouling and if necessary cleaned and softly lubricated. Likewise the lid mechanics is to be checked for fouling and proper functionality.

Damaged parts must be exchanged immediately.



Always verify the tight fit of the rotor lid by pulling the lid after locking it!

Operation without rotor lid

If you are going to operate the rotor without the rotor lid the aerosol-seals must be removed prior to use.

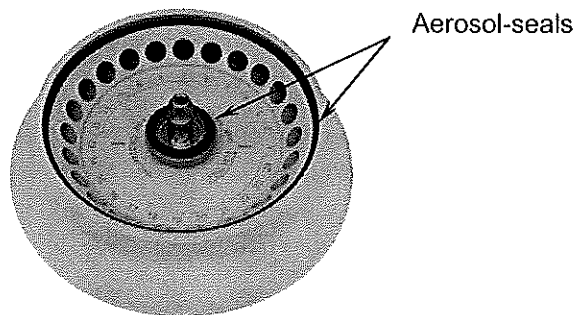

During the centrifugation without a rotor lid the aerosol seals are not longer fixed and may cause serious damage to the centrifuge!

During the operation with opened tube caps, they can break away and cause damages.

Rotor lid with screw plug

For this kind of rotor the rotor lid will be held centrally on the rotor collar.

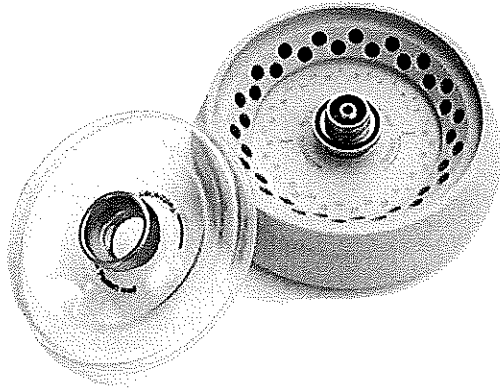

To close the rotor, place the rotor lid centrally on the rotor nut. By clockwise turning of the lid-handle the rotor lid is fixed.



These rotors are not designed for aerosoltight applications!

The O-Ring in the rotor collar provides only for tight fit of screw plug. The external lid lip can not be sealed for these rotors.



Please always verify the fixed anchorage of the rotor lid!

Aerosol-tight application



Only with the designated rotors!

See the rotor tables from page 12



Aerosol-tight rotors and tubes are only to be opened in an approved safety work bench when centrifuging dangerous samples!

It is indispensable to observe the maximum permissible filling quantities!

Tubes are only to be filled to a level where the sample does not reach the brim of the tubes during centrifugation.

Please observe the permissible filling volumes!

Nominal volume:		Permissible volume:
2.0 ml	-	1.5 ml
1.5 ml	-	1.0 ml
others	-	$\frac{2}{3}$ nominal volume



Aerosol-tight application not with open tube caps!



Attention:

Please check that your sample tubes are suitable for the centrifugal application desired:

- Gravitation fields up to 21 100xg,
- temperature in uncooled devices maximum approx. 15 K above room temperature.

Correct operation when filling the sample tubes and closing the rotor lid are prerequisites for aerosol bio-containment.



Prior to each application, the seals in the rotors have to be checked for correct fit, abrasion or damage and have to be slightly greased.

Replace damaged seals immediately!



Use only the special lubricant 7600 3500 to grease the seals!

A set of spare seals is supplied with the rotor and can be ordered separately as **spare seal set 75003405**.

The following steps have to be carried out:

- Lubricate the seals before inserting them (lubricant order no. 76003500)

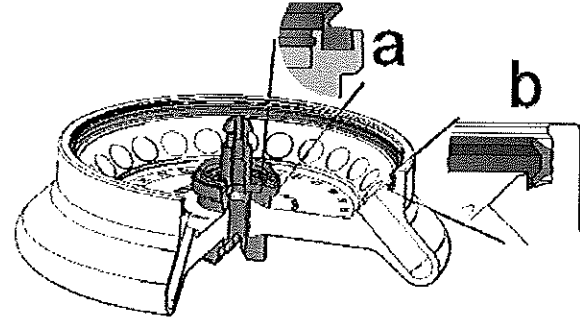

- Press the smaller V-seal into the groove of the rotor collar (a).
- Insert the seal (C-profile) in the outer groove of the rotor body (b).



Achten Sie nach dem Beladen des Rotors auf ein sicheres Schließen des Rotordeckels!



Replace damaged or dulled rotor lids promptly!

Checking for aerosol-tightness

The checking of the rotor type and bucket was done according to the dynamic microbiological test procedure with regard to EN 61010-2-020 appendix AA.

The aerosol-tight bio-containment of the rotor mainly depends on proper handling!



Check the aerosol-tight bio-containment of your rotor whenever necessary!



It is very important that all the seals and seal-surfaces are carefully inspected for wear and damages like cracks, scratches and embrittlement!

For a quick test one can check the fixed angle rotors according to the following procedure:

- Slightly grease all seals.
- Fill the rotor with approx. 10 ml carbon dioxide mineral water.
- Close the rotor according to the respective handling instructions.
- Due to the shaking, the carbon dioxide of the water is released, and an overpressure is built up. Do not press the lid simultaneously.
- Leaks are recognized by humidity release and audible disinflation of gas mix.
- In case of leakage the aerosol-seals have to be replaced and the leakage check has to be repeated.
- Dry rotor, rotor lid and lid seal.

Operation

Switching on the centrifuge

Set the main power switch of the instrument.

For a couple of seconds the following reading appears in the control panel (the temperature display field only)



for cooled instrument:

The display shows that the instrument is going through an internal check of its software.

After this check, the display switches into the current value mode. The speed and remaining run time show 0.

The refrigeration unit display shows the current temperature of the sample. (Prior to the start of the centrifuge, the display usually shows the temperature of the rotor chamber).

The following figure gives an example of possible readings of the display. A detailed description of possible settings is given below in this chapter.



Opening the lid



For activating the lid release the centrifuge must be connected to mains and switched on!

To open the lid press the „open-lid“-button .

The display reads:

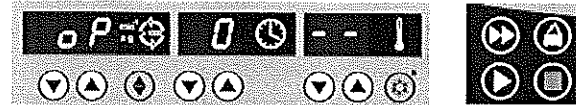

(Emergency release in case of malfunction or power failure: see chapter "Troubleshooting")

Closing the lid

The centrifuge lid is locked by slightly pressing down the front part of the lid.



Do not slam the lid!

Installing the rotor



Improper or improperly combined accessories may cause severe damage to the centrifuge!

The centrifuge rotors approved are detailed in the chapter "Accessories". Use only rotors listed for this instrument.

To insert the rotor, you need the special wrench delivered with the instrument (see chapter "accessories").

You may insert the rotor only when the temperature difference of the drive and the rotor drive shaft achieves maximum 20 °C. Otherwise the rotor may jam during the installation.



The installation of a clamping rotor can lead to damages of the drive shaft and rotor!

Proceed as follows:

1. Open the centrifuge lid and make sure that the rotor chamber and the rotor are clean. Remove eventual dust, foreign material or sample residues. The thread and the O-Ring on the motor shaft must be in perfect condition.
2. Turn the rotor so that the notch for engaging the drive shaft points downward.
3. Place the rotor on top of the drive shaft so that the notch of the rotor is located precisely above the retaining pin. (There are two bars in the labelling on the upper side of the rotor indicating the position of the notch). These bars make the positioning easy.

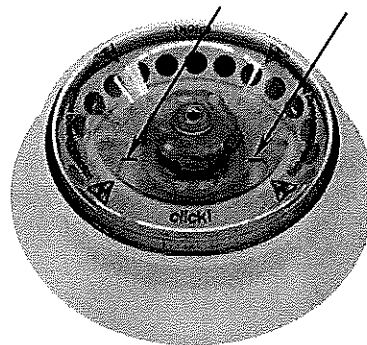

4. Press the rotor gently down until it stops.
5. Grip the rotor tightly and use the provided rotor wrench to tighten up the rotor.



Do not push the rotor down using force.

If the rotor can not be tightened, you have to remove it carefully, align the notch and the retaining pin again and re-install it.

6. Place the rotor lid onto the rotor, and attend to the tight fit of the rotor.



Check tight placement of the rotor regularly and re-tighten the rotor as needed.



Attention at the replacement of the rotor after the centrifugation!

Rotor drive and motor end shield may be hot (>55°C).



Loading the rotor

Maximum load



Overloading may cause the rotor to explode!

Exploding parts may severely damage the centrifuge!

The centrifuge can reach high rotational speeds implying enormous centrifugal force. The rotors are designed in a way warranting sufficient residual strength even at the highest permissible speed.

However, this safety system presupposes that the maximum permissible load of the rotor is not exceeded.

If you wish to centrifuge samples that together with the adapters exceed the maximum permissible load, you must either reduce the sample volume or calculate the permissible speed n_{perm} according to the following formula:

$$n_{perm} = n_{max} * \sqrt{\frac{\text{maximum permissible load}}{\text{actual load}}}$$

Filling the centrifuge tubes



Please note that plastic sample vessels only have a limited service life - particularly when used at maximum performance (rpm or temperature) - and must be replaced as necessary!



Check carefully whether your sample vessels are permissible for the respective g value and reduce the speed if necessary.

The smaller the centrifuge imbalance, the better the separation, because separated zones are no longer perturbed by vibration. It is therefore important to balance the centrifuge tubes as well as possible.

To minimize imbalance you should fill the tubes as evenly as possible. You can achieve this by eye. However, you must nonetheless ensure that opposite tubes are filled to the same level.

Placing the tubes in the rotor

The rotor must be loaded symmetrically. When loading the rotor only partially, you must ensure that opposite bores always receive tubes of equal weight (when centrifuging a single sample, place a centrifuge tube e.g. filled with water opposite). The following figure gives examples for proper loading.

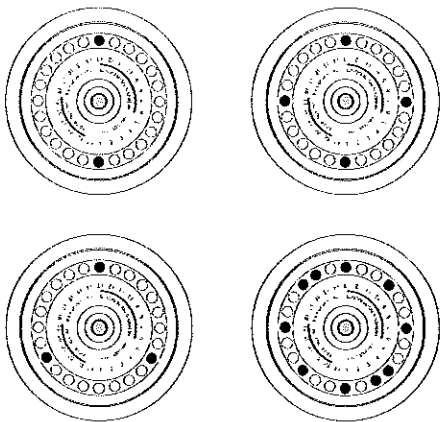

properly loaded rotors



Uneven loading may lead to damage of the rotor and centrifuge in extreme cases. Imbalance not only causes a noisy run, but also causes premature abrasion of the drive.

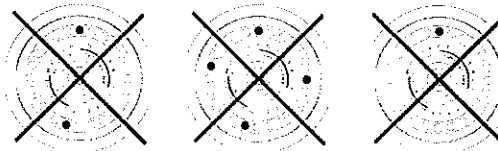

improperly loaded rotors

These examples are to be applied to the other rotors in an analogous manner!

When you have loaded the tubes, close the rotor lid.



Close the lid of the centrifuge by lightly pressing it down. The centrifuge lid must be locked audibly so that it cannot be manually reopened afterwards.

Entering parameters

Switching from speed to RCF display

Upon turning on the centrifuge, the speed display is set.



By activating the selection key  you can switch to the RCF- value or change between rpm and RCF displays.

Selecting speed

The centrifuge speed can be set to a minimum of 300 rpm. The maximum speed depends on the centrifuge version).

You can adjust the speed in 100 rpm increments.

Proceed as follows:

1. Press one of the "set" keys  (for increase) or  (for decrease) in the field "speed" of the control panel to enter the pre-selected value mode (cf. foldout leaf in the cover):

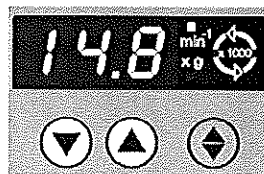

By pressing the key **briefly**, you increase or decrease the speed in one step (of 100 rpm). This option is supposed to be used for small changes and fine tuning.

2. If you hold the key pressed, the display changes continuously at first slowly and after a few seconds at an accelerated pace to the higher or lower values.
3. Release the key as soon as you reached the desired value and fine tune if necessary by repeatedly briefly pressing the selected key). The first digit behind the decimal point flashes for a few seconds and then switches permanently into the current value mode. The new pre-selected speed is now stored.

Entering the RCF value

You can adjust the RCF pre-selected value in steps of 100 xg. The setting of pre-selected value is entered analogously to the speed.

The RCF value can be set to a minimum of 100xg. The setting of a maximum RCF depends on the type of centrifuge.

 The displayed RCF value is always corresponding to the maximum of centrifuge radius of the micro liter rotor 24 x 2ml (7500 3424).

For other rotors please use the formula beneath or follow the enclosed speed/RCF diagrams.

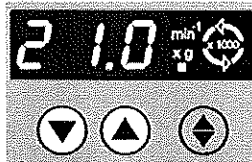

 **Mind the rounding difference!**

Due to limited display digits there is a need to round the values. The direct comparison between the two values speed and RCF is therefore restricted.

Concerning the RCF value

The relative centrifugal force (RCF) is given in multiples of the earth gravity g . It is a dimensionless number value that allows one to compare the efficiency of separation or sedimentation of diverse instruments, since it is independent of the instrument used. The only values entered in the equation are radius and speed of centrifugation:

$$RCF = 11.18 * \left(\frac{n}{1000} \right)^2 * r$$

r = radius of centrifugation in cm

n = speed in rpm

The maximum RCF value refers to the maximum radius of the vessel bore.

 Please note that this value becomes lower depending on the tubes and adapters used.



You may take this into account when calculating the RCF value for your application.

Selecting the run time

You can select a run time between 1 and 99 min or continuous operation [hd].

Run time selection

To predetermine the fixed run time, proceed as follows:

1. Press one of the "set" keys  (for increase) or  (for decrease) in the field "time" of the control panel to enter the pre-selected value mode (cf. foldout leaf in the cover):

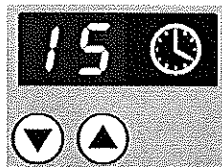

By pressing the selected key briefly, you increase or decrease the preset run time in steps of 1 min. This option is supposed to be used for small changes and fine tuning.

2. If you keep the key pressed, the display changes at first slowly and after a few seconds at an accelerated pace to the higher or lower values.

3. Release the key as soon as you have reached the desired value and fine tune if necessary by repeatedly briefly pressing one of the keys. The run time display flashes for a number of seconds, then changes to permanent display of the current value mode. The new pre-selected run time is now stored.

Continuous operation

To operate the centrifuge in the continuous mode, you must press the key  until the display changes to „hd“ (for "hold").

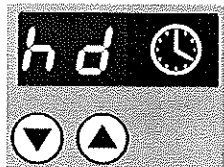



In this mode the centrifuge runs until you stop the run by manually pressing the „Stop“-button .



Please note that the lifetime of particularly plastic rotor tubes is limited. Continuous operation (extended use) may cause damage to them!

Setting the temperature

To determine the sample temperature for instruments with refrigeration unit, operate as advised:

1. Press one of the "set" keys  (for increase) or  (for decrease) in the the field "temperature" of the control panel to enter the pre-selected value mode (cf. foldout leaf in the cover):

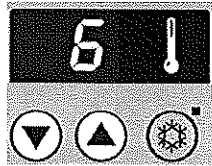

By pressing the key **briefly**, you increase or decrease the temperature in steps of 1 °C.

This option is supposed to be used for small changes and fine tuning.

2. If you keep the key pressed, the display changes at first slowly and after a few seconds at an accelerated pace to the higher or lower values.

3. Release the key as soon as you are close to the desired value and fine tune if necessary by repeatedly briefly pressing the key. The display flashes for a few seconds and then turns to permanent display of the current value mode. The new pre-selected temperature is now stored.

The refrigeration starts operating after closing the centrifuge lid, at once if the pre-selected temperature is below the current temperature of the rotor chamber

Pretemp

The pretemp-function allows quick and easy tempering of the unloaded rotor.

After calling the function by pressing the key  only the desired temperature still must be choosed.

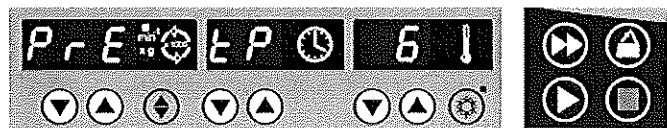

(If any other key is pressed, the pretemp function will be quit).

After activating the „start“ key  the rotor will be operated at optimal speed until the the desired temperature is reached.

An LED above the  key indicates operation at the activated pretemp function.

If you wish to change the temperature of your samples, please consider that the time required for temperature adjustment is prolonged. The farther apart initial and final temperature, the longer it takes for the temperature to adjust.



The temperature reading does not give the change in the temperature of the sample (the temperature display reading is delayed with respect to the /actual/ sample temperature change). You can neither witness the heating nor the cooling of the samples directly. For critical applications you should take other precautions to ensure that the desired temperature is actually reached and maintained (e.g. by measuring the temperature immediately after the centrifugation run).

Starting the centrifuge

Once the rotor is properly installed, the main switch turned on and the lid closed, you can start the centrifuge.

Press the "start" key  in the control panel. The centrifuge accelerates to the pre-selected value, simultaneously, the run time display starts counting backwards per minute. If the remaining run time of one minute is under-run, the time display switches to counting seconds.

The rotating light in the speed display indicates that the centrifuge is running.

During continuous operation "hd", the run time is displayed in forward run. Display first starts per second, after one minute the display switches to minutes.



During the run, you cannot open the lid.

Changing the settings during the run

You can change the settings while the rotor is spinning. Through a one-time pressing of any key of the control panel, the current value will switch into the pre-selecting value mode.

The to be altered value flashes, and can then be changed. Once the display switches into the current value mode after completion of the entered values, the new values are activated.

You can stop the centrifuge at any time by pressing the "stop" key .

Stopping the centrifuge



Preset run time

Normally the run time has been pre-selected, and all you have to do, is to wait until the centrifuge terminates the run automatically.

As soon as the speed is down to zero, the display reads "End". By pressing the "open lid" key , you can now open the lid and remove your centrifugation samples.

You can stop the centrifuge at any time by pressing the "stop" key .

Continuous operation

If you have chosen continuous operation, you must stop the centrifuge manually. Press the "stop" key  in the control panel. The centrifuge starts braking at once and stops within a few seconds. The display reads "End", the electrical lid unlocking mechanism is available. You can now open the lid by pressing the "open lid" key  and remove your centrifugation samples.

Short-time centrifugation

For short-term operation, the centrifuge is equipped with the "quick run" function.

Short-term centrifugation is started by pressing the "quick run" key  continuously; it stops as soon as the key is released.

In this mode the centrifuge accelerates with full power up to the maximum speed unless you release the "quick run" key .

The pre-selected speed is ignored.



The centrifuge accelerates to the maximum speed.

Check carefully whether you have to maintain a specific speed limit for your application.

During the activating of the "quick run" key  first the time is counted forward in seconds. After 60 seconds the display changes to the minute cycles.

Removing the rotor

To remove the rotor you have to proceed in the reverse order as at the installation of the rotor.

In case of contamination you can remove the rotor from the drive shaft without opening the aerosol lid. Then you can open the removed rotor e.g. in a safety work bench and decontaminate it.



1. Open the centrifuge lid.
2. Unscrew the rotor nut with the provided. Turn the rotor nut counterclockwise.
3. Grab the rotor centrally and carefully pull it perpendicularly off the drive shaft. Make sure not to tilt it.

Audible alarm

Accompanying all error messages, a warning signal is given out which can be silenced upon pressing any key.

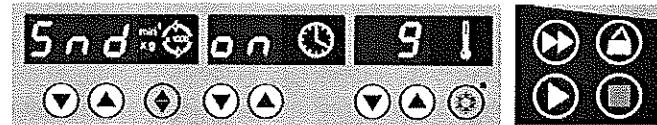
By default there is an acoustic signal at the end of any centrifugation run. You have the possibility to switch off this signal. For this, you have to press the „speed/ RCF switch key“  while switching on the centrifuge.



Depending on the pre-selected mode the display shows the following signs: „Snd“ „on“ or „Snd“ „oF“. By pressing the set keys  or  in the field „time“ the acoustic signal function can be turned off or on. Subsequently, by pressing the stop key  the new setting will be activated.

Turning off the centrifuge

The centrifuge is turned off by switching the main switch into the "0" position.



The main power switch should be turned off after a complete centrifugation run. Without motor deceleration, it takes much longer until the rotor comes to a halt.



The centrifuge is equipped with a special switch for balancing potential voltage discrepancies in the power grid. After pressing the mains switch the display therefore may still flash up to 10 seconds.



The opening of the centrifuge lid is only possible by means of „lid open“-key  while the centrifuge is switched on!

WEEE Compliance:

This product is required to comply with the European Union's Waste Electrical & Electronic Equipment (WEEE) Directive 2002/96/EC. It is marked with the following symbol:

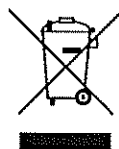

Fisher Scientific® has contracted with recycling / disposal companies in each EU Member State, and this product should be disposed of or recycled through them.

Further information on Fisher Scientific's compliance with these Directives, the recyclers in your country, and information on Fisher Scientific® products which may assist the detection (EU-standard on the limitation of hazardous substances) of substances subject to the RoHS Directive are available at

www.fishersci.com

Maintenance and care

Maintenance to be performed by the customer

For the protection of persons, environment and material you are obliged to clean the centrifuge regularly and to disinfect it if necessary.



Unsuitable cleaning agents or disinfection procedures may damage the centrifuge and its accessories!

Before using cleaning agents or disinfection procedures not recommended by the manufacturer, the user have to make sure by consulting the manufacturer, that the procedure foreseen does not cause any damages to the instrument!

Instruments with refrigeration unit:



If a strong ice sheet is present in the internal chamber, be sure to remove all condensate after defrosting!

Cleaning



Pull mains plug before cleaning the instrument!

Clean the casing, the rotor chamber, the rotor and the accessories regularly and in case of need. This is indicated both for reasons of hygiene and to prevent corrosion due to contamination sticking to the instrument and its accessories.

Clean them with mild agents of pH values ranging from 6 to 8.

Immediately after cleaning, dry the aluminum parts or put them into a warm-air dryer at a temperature not exceeding 50°C.



During cleaning liquids and especially organic solvents should not come into contact with the drive shaft and the ball bearing.

Organic solvents may decompose the lubricant of the motor bearing causing the drive shaft to lock.

 Please clean the venting slots regularly!

To protect the refrigeration unit, the cooled devices are equipped with an air filter unit.

Depending on the environment situation it is recommended to clean the filter at least every three months.



Disconnect the centrifuge from mains switch before cleaning the venting slots and the filter unit.

Pull the cord!

Cleaning the filter unit

To remove the filter unit pull the centrifuge to the edge of the table.

Pull the clip below the sucking grid down and remove the filter unit completely by pulling down.

A soft cloth now easily removes the cumulated dust.

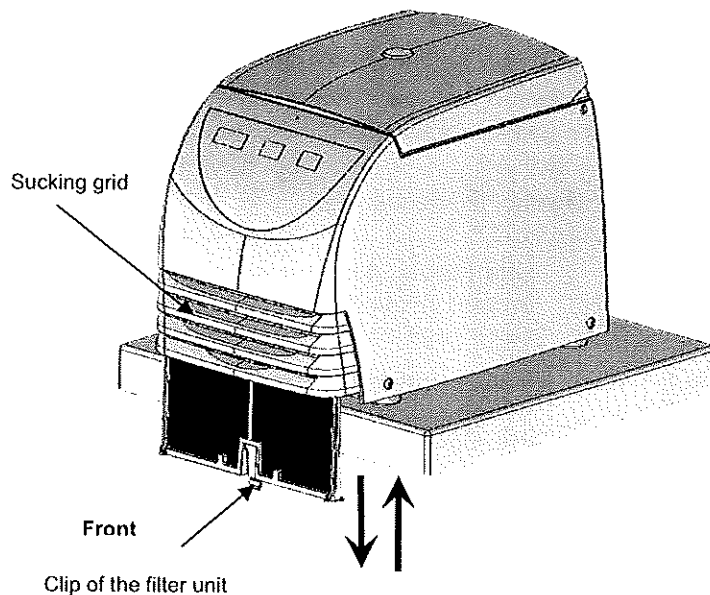

Please observe the labeling „front“ and „rear“ on the clip when inserting the filter into the centrifuge! **“Front”** must show to the front of the centrifuge.

Push the filter upwards into the slot until the clip locks in the bottom plate.

Disinfection

If a centrifuge tube containing infectious material leaks, during a centrifugation run, you have to disinfect immediately the rotor, and/or also the centrifuge.

Rotor and rotor chamber must be treated with a neutral, universal disinfectant. Best suited for this purpose are disinfectant sprays, ensuring that all rotor and accessory surfaces are covered evenly.



Infectious material could enter the centrifuge if spills or tube breakage occur. Danger of infection may occur upon contact!

Take appropriate protective measures for personnel!

Mind the permissible filling volumes and loading limits for the tubes!

In case of contamination the operator has to make sure, that no further persons are jeopardized!

Contaminated parts have to be decontaminated immediately.

If required further protective measures have to be initiated.



Please note the safety measures and handling hints when applying these substances!

You may disinfect the rotor and the accessories as described in the following section. Be sure to follow the pertinent safety procedures for handling infectious material.

1. Unplug mains cord.
2. Unscrew the rotor from the shaft.
3. Grab the rotor with both hands and pull it perpendicularly off the drive shaft.
4. Remove the centrifuge tubes and adapters, and disinfect them or dispose of them as necessary.

5. Treat the rotor and the rotor lid according to the instructions given for the disinfectant (soaking in liquid or spraying). You must strictly observe the specified action times!
6. Turn the rotor head down and drain off the disinfectant. Thereafter thoroughly rinse rotor and lid with water.
7. Dispose of the disinfectant according to valid regulations.
8. Aluminum rotors have to be treated with anticorrosive protective oil subsequently.
9. All seals have to be lubricated again.

Disinfection with bleaching lye



These agents contain highly aggressive hypochlorites and must not be used with aluminum rotors!

The following precautionary measures are to be taken for extensive protection of the plastic rotors:

1. Avoid high temperatures!
The bleaching solution and the rotor should not be warmer than ca. 25 °C.
2. Do not let the bleaching solution act longer than absolutely necessary!
3. After disinfection, rinse the rotor thoroughly with distilled water and allow drying.
4. All seals have to be lubricated again

Decontamination

For general radioactive decontamination, use a solution of equal parts of 70% ethanol, 10% SDS and water. Follow this with ethanol rinses, then de-ionized water rinses, and dry with a soft absorbent cloth. Dispose of all washing solutions in appropriate radioactive waste containers!

Autoclaving



Check whether autoclaving is permitted!

You may autoclave the rotor, rotor lid and the adapters at 121 °C.

Maximum permissible autoclaving cycle:
20 minutes at 121 °C.



For safety reasons, the plastic rotors and rotor lids must only be subjected to a maximum of 20 autoclaving cycles!

The rotor must be cleaned and rinsed with distilled water before being autoclaved. Remove the rotor lid, the centrifuge tubes and the adapters. Place plastic rotors on an even surface to avoid deformation.



Chemical additives to the steam are not permitted.



Never exceed the maximum permissible values for autoclaving temperature and autoclaving time.

Should the rotor show signs of wear or corrosion, you must stop using it!

Troubleshooting

Mechanical emergency lid release

In case of a power failure you cannot open the lid normally using the electric emergency release. To permit unloading even in this case, the centrifuge is equipped with a hand operated lid unlocking system. However, you may use this system **only** in case of emergency.



**Rotor can spin at high speed!
Touching it may cause severe injuries!**

Always wait for several minutes until the rotor has come to a complete standstill without deceleration. Without power the brake does not function, and braking takes much longer than normal!

Should it be necessary to open the lid manually, proceed as follows using an appropriate/special tool:

1. Make sure the rotor stands still. (control window).
2. Unplug the mains cord.
3. Push a small straight wire of a length of approx. 7cm (e.g. a bended paper clip etc.) through the hole located in the middle above the display, at the chamber edge.

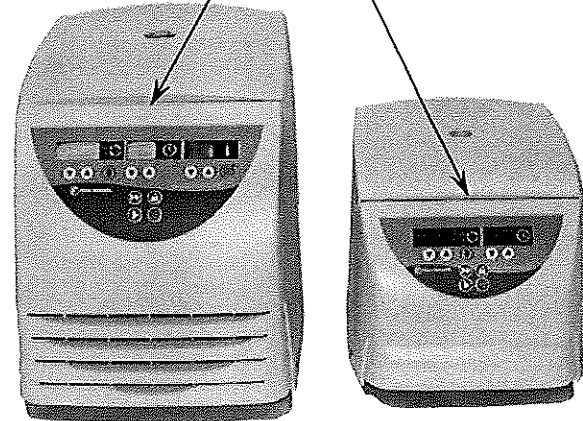

4. Gently press the centrifuge lid down to disengage the lid-latch.
5. While pressing down the lid push the wire down further until you hear and feel the lid-latch unlocking. Remove the auxiliary tool and open the centrifuge lid.
6. In case the rotor still turns, close centrifuge lid immediately and wait until it has come to a complete standstill.



Never brake the rotor using your hands or tools!

7. As soon as the rotor stands still, remove your samples and close the centrifuge lid.

Problems you can handle yourself



If problems other than those described in the following tables arise, you must consult your nearest authorized service.

Error	Symptom	Possible causes and corrective measures
Displays remain dark	The drive stops. The rotor stops without deceleration. The lid cannot be opened.	Mains voltage disconnection 1. Is the mains switch turned on? 2. Check the mains connection. If the mains connection is ok, contact the service representative.
Displays fail briefly.	The drive stops suddenly. The rotor stops without deceleration.	Main connection was briefly interrupted 1. Turn off mains switch. 2. Check whether the mains power cord is connected properly. 3. Restart the centrifuge.
Centrifuge lid cannot be opened.	Pressing the "open lid" key has no effect.	Centrifuge lid not correctly engaged or lid warped. 1. Check if mains connection is working and the instrument is switched on (display is lit). 2. If this is unsuccessful, you may open the centrifuge lid using the mechanical emergency lid release (see page 43).

Troubleshooting

Error	Symptom	Possible causes and corrective measures
-	Exceptionally running noise.	<p>Imbalance.</p> <ol style="list-style-type: none"> 1. Stop the centrifuge by pressing the "stop" key, in case of emergency, unplug mains power cord. 2. Wait until the centrifuge comes to a complete stop. 3. Check whether the rotor is properly loaded. 4. Check whether a broken tube, damage to the rotor or motor is responsible for the run noise. <p>If you cannot locate and solve the problem yourself, contact a service representative</p>
Display "oP" appears although lid is closed.	Will not start.	<p>Centrifuge lid not properly closed</p> <p>- Open the lid and repeat locking procedure.</p> <p>If you cannot locate and solve the problem yourself, contact a service representative.</p>
"Lid"	Rotor stops with deceleration to standstill.	<p>Centrifuge lid was opened manually during the run.</p> <p>- Close centrifuge lid immediately</p> <p>The instrument phases out with deceleration.</p> <p>For further centrifugation, you have to switch the instrument off and switch it on again.</p>

Error	Symptom	Possible causes and corrective measures
„bAL“	The rotor stops with deceleration.	<p>Imbalance switch releases.</p> <ol style="list-style-type: none"> 1. Open the instrument by pressing the “lid open”  in case. 2. Check whether the rotor is properly loaded. 3. Check whether a broken tube or a damage to the rotor release the imbalance switch. <p>If you cannot locate and solve the problem yourself, contact a service representative.</p>
E-01 E-13	Rotor stops without deceleration to standstill. Instrument cannot be operated.	<p>Internal program error.</p> <p>Switch the instrument off and on again.</p> <p>If the error persists, contact service representative.</p>
E-14	Rotor stops with deceleration to standstill. Instrument cannot be operated.	<p>Overtemperature in the centrifuge chamber.</p> <p>Switch the centrifuge off and turn it on again after approx. one minute.</p> <p>If the error persists, contact service representative.</p>
E-15 E-16	Rotor stops with deceleration to standstill. Instrument cannot be operated.	<p>Temperature measurement error.</p> <p>Switch the instrument off and on again.</p> <p>If the error persists, contact service representative.</p>

Troubleshooting

Error	Symptom	Possible causes and corrective measures
E-22/E-23	Rotor stops without deceleration to standstill. Instrument cannot be operated.	<p>Error in speed entry</p> <p>Switch the instrument off and on again.</p> <p>If the error persists, contact service representative.</p>
E-24	Instrument cannot be operated.	<p>Wrong status information from the lid-latch.</p> <ol style="list-style-type: none"> 1. Turn the centrifuge off and on. 2. After re-switching on, the display shows "<i>LID FAIL</i>" 3. If the centrifuge lid has been already opened, the display shows "<i>CLOSE LID</i>". Thereupon close the lid. 4. The centrifuge tries to open the lid to switch for starting the normal operation mode. <p>If the error persists, contact service representative.</p>
E-29	Motor does not start.	<p>Motor or rotor blocked.</p> <ol style="list-style-type: none"> 1. Switch instrument off and on again using the mains switch. 2. Open the centrifuge lid. 3. Check whether the rotor can turn freely. <p>If you cannot clear the malfunction, contact a service representative.</p>

Error	Symptom	Possible causes and corrective measures
E-31	Rotor stops without deceleration to standstill or does not start.	<p>Overtemperature in the motor.</p> <ol style="list-style-type: none"> 1. Turn instrument off and unplug mains power cord. 2. Check and clean the venting slots if necessary and respectively the filter unit of the cooled centrifuge. 3. After approx. 60 minutes you can restart the instrument. <p>Observe the maximum permissible environmental temperature!</p> <p>If the error persists, contact a service representative.</p>
E-33	Rotor stops with deceleration to standstill or does not start.	<p>Overpressure in the refrigeration system</p> <ol style="list-style-type: none"> 1. Turn instrument off and unplug mains power cord. 2. Check and clean the venting slots if necessary and respectively the filter unit of the cooled centrifuge 3. After approx. 60 min. you can restart the instrument. <p>Observe the maximum permissible environmental temperature!</p> <p>If the error persists, contact a service representative.</p>
E-36	Rotor stops without deceleration to standstill. Instrument cannot be operated.	<p>Overcurrent or error in current measurement.</p> <p>Switch the instrument off and on again.</p> <p>If the error persists, contact service representative.</p>

Troubleshooting

Error	Symptom	Possible causes and corrective measures
E-41 E-56	Rotor stops without deceleration to standstill. Instrument cannot be operated.	<p>Internal program error.</p> <p>Switch the instrument off and on again.</p> <p>If the error persists, contact service representative.</p>
E-60	Rotor stops with deceleration.	<p>Insufficient temperature in the refrigeration unit.</p> <ol style="list-style-type: none"> 1. Stop the centrifugation run. 2. Open the centrifuge lid, defrost the chamber <div data-bbox="781 495 1422 610" style="border: 1px solid black; padding: 5px; margin: 10px 0;">  <p>Never touch the chamber directly with your hands – you may freeze up!</p> </div> <ol style="list-style-type: none"> 3. After approx. 60 minutes you can restart the instrument. Observe the maximum permissible environmental temperature! 4. If a strong ice sheet is present in the internal chamber, be sure to remove all condensate after defrosting <p>If the error persists, contact service representative.</p>

Contacting Service

Should you require help from your service representative, please indicate the catalog and serial number of your instrument. You will find the pertinent information at the specifications, near the socket for the main plug.

Moreover it is helpful for our service representative to know your software version. You can determine the software version as follows:

1. Switch the instrument off.
2. Keep „stop“ key  pressed and switch on the instrument

For approx. 1 second all displays read:

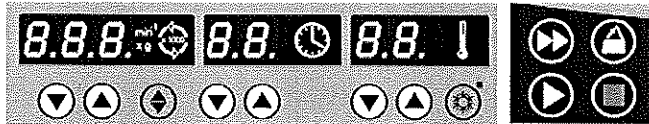

Subsequently, the following readings will be displayed for 5 seconds each

Software number	<i>SOFT</i>	<i>0 5 8</i>	<i>3 _</i>
Software version		<i>_ 0 1</i>	
NV-RAM number	<i>EEPRO</i>	<i>4 6 2</i>	<i>1 _</i>
NV-RAM version		<i>_ 0 1</i>	

The last information displayed indicates the current cycle status.

Cycle counter	<i>CYCLE</i>	<i>0 0 1</i>	<i>2 5</i>
---------------	--------------	--------------	------------

The values shown above are just examples. Your readings may be different. In the example shown here the values mean the following:

- Software 0583 version 01
- NV-Ram 4621 version 01
- 125 cycles completes

Troubleshooting





for your notes

Technical data

Component parts

Part / function	Description
Housing/body	Sheet steel chassis with attached plastic housing and steel reinforcement
Keys and display panel	Keys and display panel covered with easy care protective foil
Operation	"Easycontrol" system
Rotor chamber dimensions (D x H) (diameter x height): accuSpin Micro 17 accuSpin Micro 17R	190 mm x 70 mm 200 mm x 75 mm
Chamber	Up to 48 ml of spilled liquids are retained in the chamber and cannot enter the instrument.
Lid lock	Automatic locking when the lid is pressed shut
Lid opening	Electromagnetic release via the "open lid" key  when connected to mains
Emergency lid release	Lid release in case of power failure: emergency opening with auxiliary tool.

The "Easycontrol" user interface

Function	Performance
Start	Start key ()
Stop	Stop key ()
Quick starting and stopping	"Quick run" key (): short-time run when pressed permanently; stop when released
Indication of operating state	Spinning rotor indicated by rotating lights (LED) in the speed display panel
End of centrifugation	Speed display reads "End"
Cycle counter	The cycle counter is displayed while switching on the centrifuge and simultaneously pressing the „Stop“-button 
Digital parameter display	<ul style="list-style-type: none"> • speed/RCF • run time • temperature* (only for refrigeration units)
Speed selection	adjustable in steps of 100 min^{-1} in the range 300 min^{-1} to n_{max} *
Run time selection	adjustable in minutes between 1 min and 99 min; "hd" mode: continuous operation
Time display in "quick run" mode	between 1 s and 60 s in seconds, above 60 s in minutes

*depending on the instrument

Performance

Performance	Value/description (accuSpin Micro 17/ 17R in parentheses)
environmental conditions	<ul style="list-style-type: none"> - indoor use - maximum elevation 2000 m above sea level - maximum relative humidity 80 % up to 31 °C; linearly decreasing down to 50 % relative humidity at 40 °C.
permissible temperature of the environment	5 °C to + 40 °C during operation (no condensation) -10 °C to 50 °C for storage and shipping
minimum speed n_{\min}	300 min^{-1}
maximum speed n_{\max}	14 800 min^{-1} (13 300 min^{-1})
maximum RCF value at n_{\max}	21 000 (17 000) Micro liter rotor 24 x 2ml 7500 3424
maximum kinetic energy	2.35 kNm (1.90 kNm)
set temperature range AccuSpin Micro 17R	adjustable in steps of 1°C between -9 °C and 40 °C
noise at maximum speed AccuSpin Micro 17 AccuSpin Micro 17R	56 dB (A) 50 dB (A)

Electrical connections

Order no.	Voltage	Frequency	Nominal current	Power consumption	Fuses inside instrument *
accuSpin Micro 17 7500 2460	230 V	50/60 Hz	1,4 A	180 W	2 x 4,0 AT 250V (5 x 20 mm)
accuSpin Micro 17 7500 2461	120 V	60 Hz	2,6 A	180 W	2 x 6,3 AT 250V (6,3 x 32 mm)
accuSpin Micro 17R 7500 2462	230 V	50/60 Hz	1,9 A	320 W	2 x 4,0 AT 250V (5 x 20 mm)
accuSpin Micro 17R 7500 2463	120 V	60 Hz	3,9 A	330 W	2 x 6,3 AT 250V (6,3 x 32 mm)

* The fuse may be replaced only by authorized servicing personnel!

Technical data

for your notes

Appendix

Speed/RCF diagram

Speed/RCF diagram

Micro liter rotor 24 x 2 ml 7500 3424

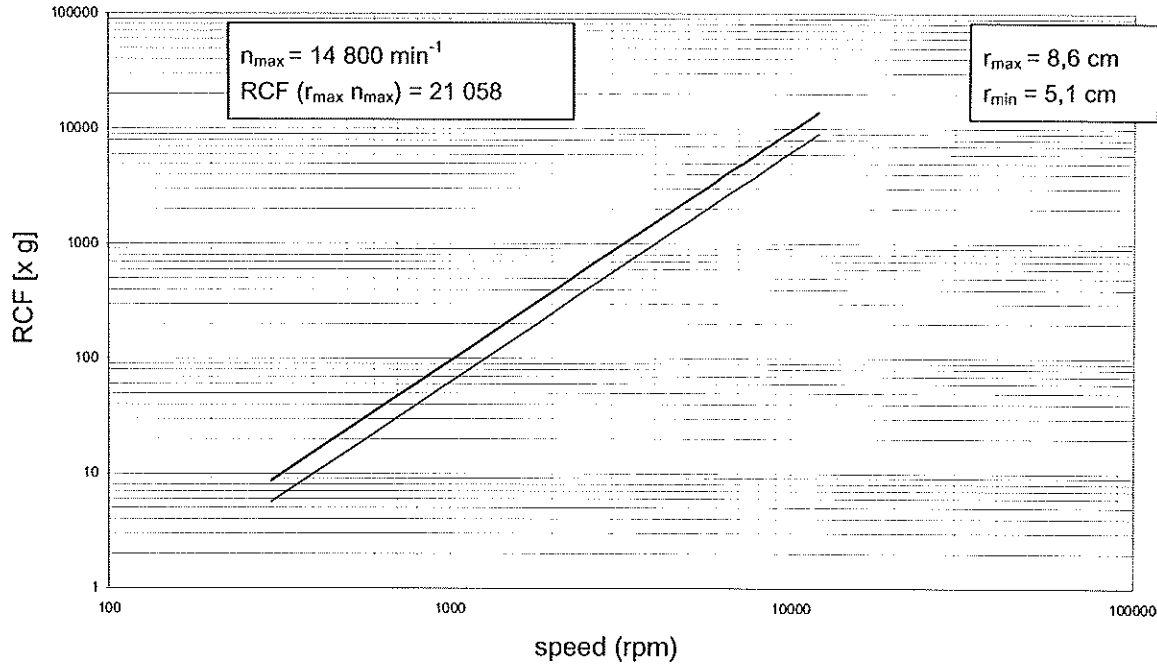

Speed/RCF diagram

Micro liter rotor 36 x 0,5 ml 75003436

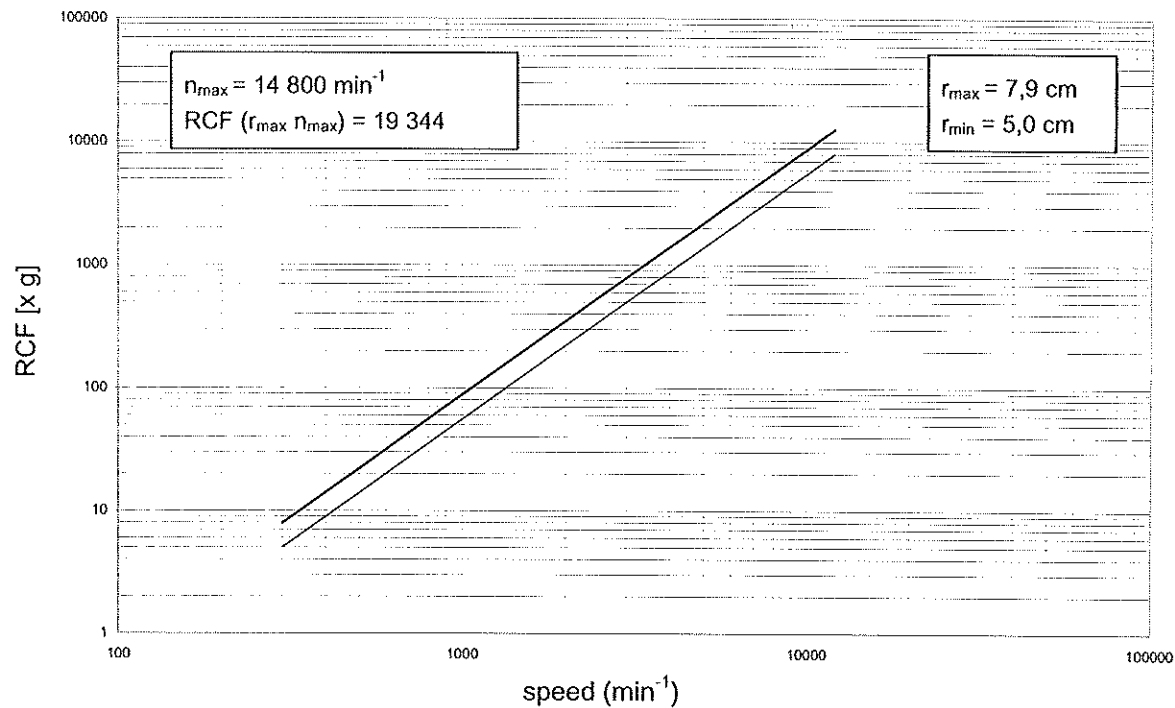

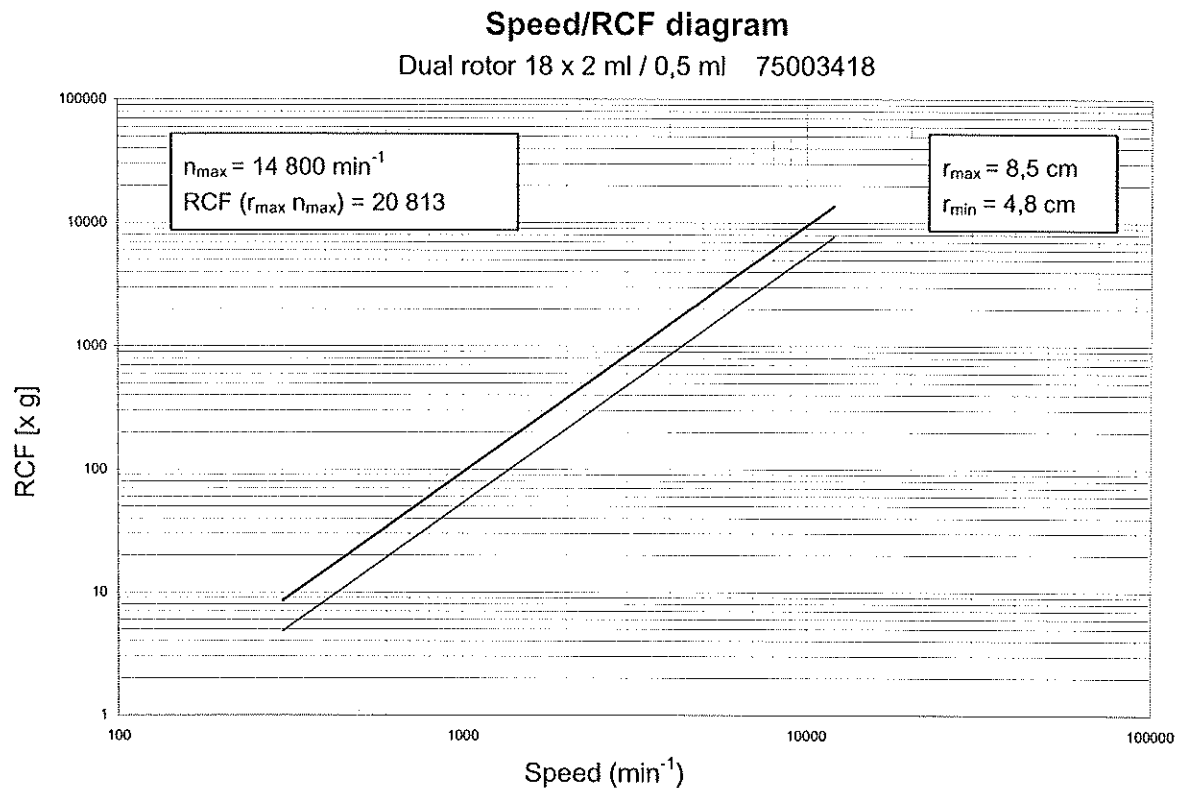

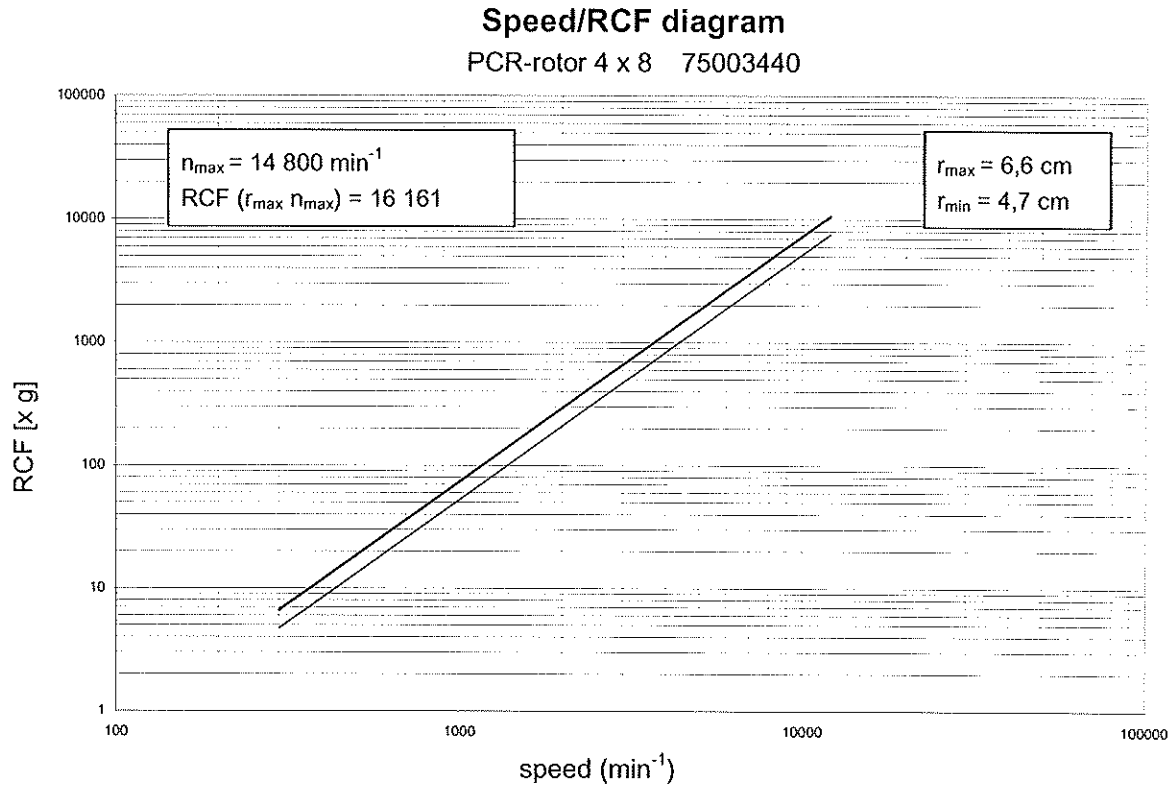

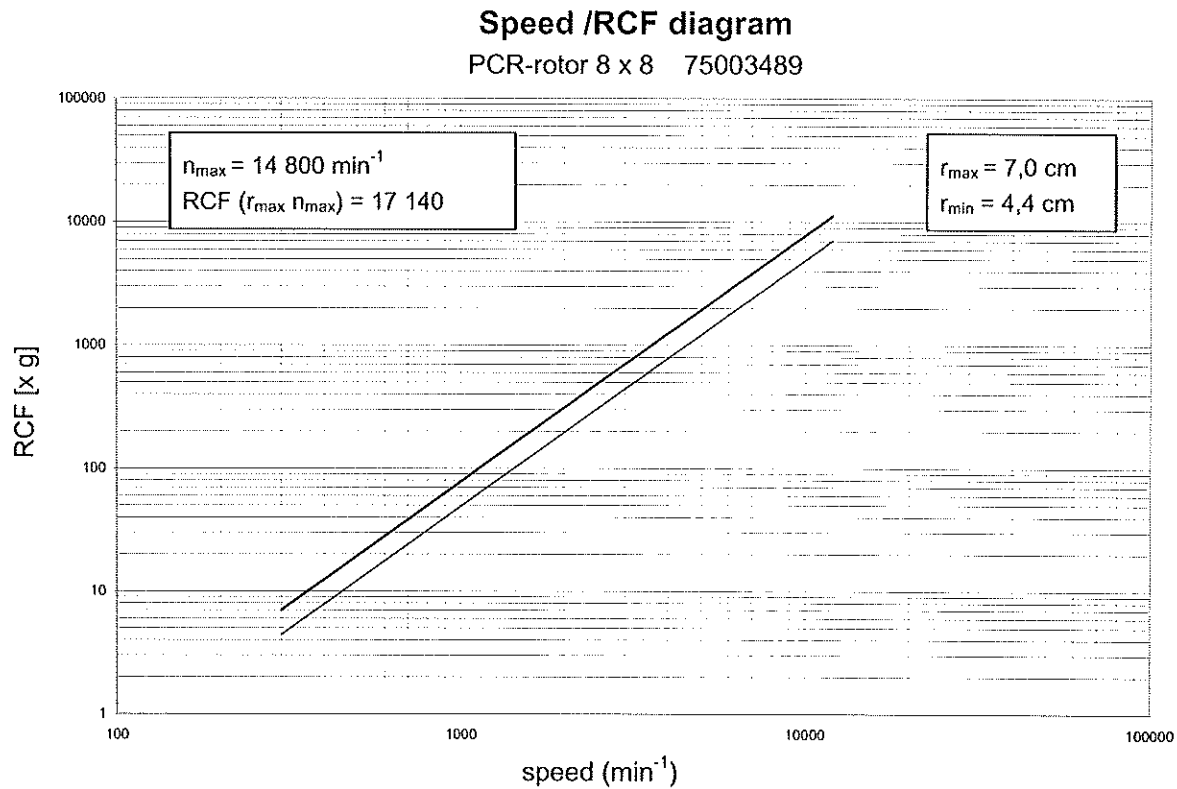

For your notes

Autoclaving protocol				
	Date	Remark	Operator	Signature
1				
2				
3				
4				
5				
6				
7				
8				
9				
10				

Autoclaving protocol				
	Date	Remark	Operator	Signature
11				
12				
13				
14				
15				
16				
17				
18				
19				
20				

Appendix

For your notes

Index

A

- acceleration 8
- acceleration time 12, 13
- accessories
 - rotor 11
- Adapter 16
- aerosol-tight 12, 13, 22
- aerosol-tightness
 - test 22
- aluminum rotor: 40
- approved rotors 24
- autoclaving 41
- autoclaving cycle
 - permissible maximum 41

C

- centrifuge
 - starting 33
- centrifuge exceptionally noisy 46
- centrifuge tubes
 - types 11
 - volume range 11
- cleaning 37
- common glass or plastic centrifuge tubes 4
- Conformity 5

- contamination
 - necessary measures 39
- continuous operation 30, 34
- corrosion 4
- corrosive substances
 - protective tubes for corrosive substances 4

D

- damage
 - symbol for potential 3
- dangerous chemicals 4
- deceleration time 12, 13
- decontamination 39, 41
- Decontamination 41
- dimensions 56
- disinfectant 39
- disinfection 4
 - procedure 39
- display
 - during run 33
- displays
 - brief failure 45

E

- electrical connections 57
- error codes

Index

„OPEN" with lid closed 46
error codes
E-01 ... E-60 47

F

fine tuning
temperature 31
fixed-angle rotor 11
formula
maximum permissible load 26
fuses 57

H

handling the centrifuge 4
Handling the rotor 17
hazardous substances 4
hints
symbol for 3

I

icons
for denoting dangers and potential damage 3
indoor use 9
infectious material
precautions in case of tube breakage 39
installation

place of 9
Installing the rotor 24

K

key
"quick run" 8
"start" 33
keys
general operation 8
kinetic energy 55

L

lid
blockage 45
Lid lock with safety check 7
light
rotating 33
location 9
lubricant 21, 37

M

mains connection 10
maintenance 37
manual lid release 43
manual stop 33, 34
Maximum loading 26

maximum permissible load
 formula for 26
maximum sample density 4
mechanical lid release 43

N

noise 55
noise suppression g 56

O

operation
 continuous 34
 preselected run time 30
 short-time 34
Order no. 57
organic solvents
 not allowed for cleaning 37
overloading
 dangers implied 26

P

partial loading
 of rotor 27
pathogenic microorganisms
 protection against 4
permissible speed 26

Placing the tubes 27
power supply 10
power switch 23
pretemp 32
problems
 handling of 45
protective tubes
 for corrosive substances 4

Q

quick run function 34
quick run key 8

R

radius 12, 13, 29
radius of centrifugation
 for calculation of RCF value 29
RCF 12, 13, 28, 29, 55
RCF setpoint 29
RCF value
 relative centrifugal force 29
recycling 36
reduction sleeve 16
refrigeration unit 37
relative centrifugal force 29
remain dark 45
Removing the rotor 35
rotating light 33

Index

- rotor 17, 41
 - loading 27
 - partial loading 27
- rotor cap 25
- rotor insertion
 - temperature 24
- rotor wrench 35
- rotors
 - approved 24
- run time
 - continuous operation 30
 - range 30
 - setting 30

S

- safety instructions 3
- safety measures 4
- safety standards 5
- safety systems 4
- safety zone 4
 - 30 cm around centrifuge 9
- sample density
 - maximum 4
- Selecting speed 28
- setting
 - run time 30
 - speed 28
- settings
 - change during run 33

- short-time operation 34
- site of installation 9
- software check
 - internal 23
- software version
 - determination 51
- speed 28
 - permissible 26
- speed, maximum 12, 13, 55
- start key 33
- starting run 33
- stopping 34
- substructure 9
- Switching from speed to RCF display and vice versa 28

T

- technical data 53
- temperature
 - fine tuning 31
- test
 - aerosol-tightness 22
- Testing standards 56
- tools for installing the rotor 24
- toxins
 - protection against 4
- transport
 - precautions for 9
- Transport 9
- transport protection 10

tube
 breakage with infectious material 39
tubes
 types 11
 volume range 11
Turning the centrifuge off 36

U

unbalance detection 27

W

warning signal 35
wear 4
weight 56
wrench
 for rotor insertion 24

for your notes