

X-ray microscopy

Slides: <https://tinyurl.com/ydywtr94>

Chris Jacobsen

Argonne Distinguished Fellow
Advanced Photon Source
Argonne National Laboratory
Argonne, Illinois, USA

Professor, Department of Physics &
Astronomy; Applied Physics;
Chemistry of Life Processes
Institute
Northwestern University
Evanston, Illinois, USA

NU web page:
<http://xrm.phys.northwestern.edu>

Support: Basic Energy Sciences, US Department of Energy; National Institutes of Health

Lord Rayleigh (John William Strutt) and telescopes

- Diffraction from a circular aperture limits the angular resolution of telescopes
- Diffraction is described by the Airy function with a first minimum at $\nu=1.22\pi$:

$$\left[2J_1(\nu)/\nu\right]^2$$

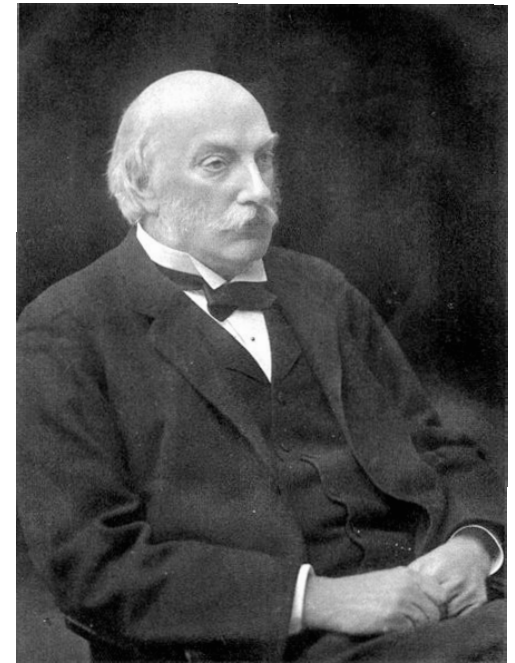
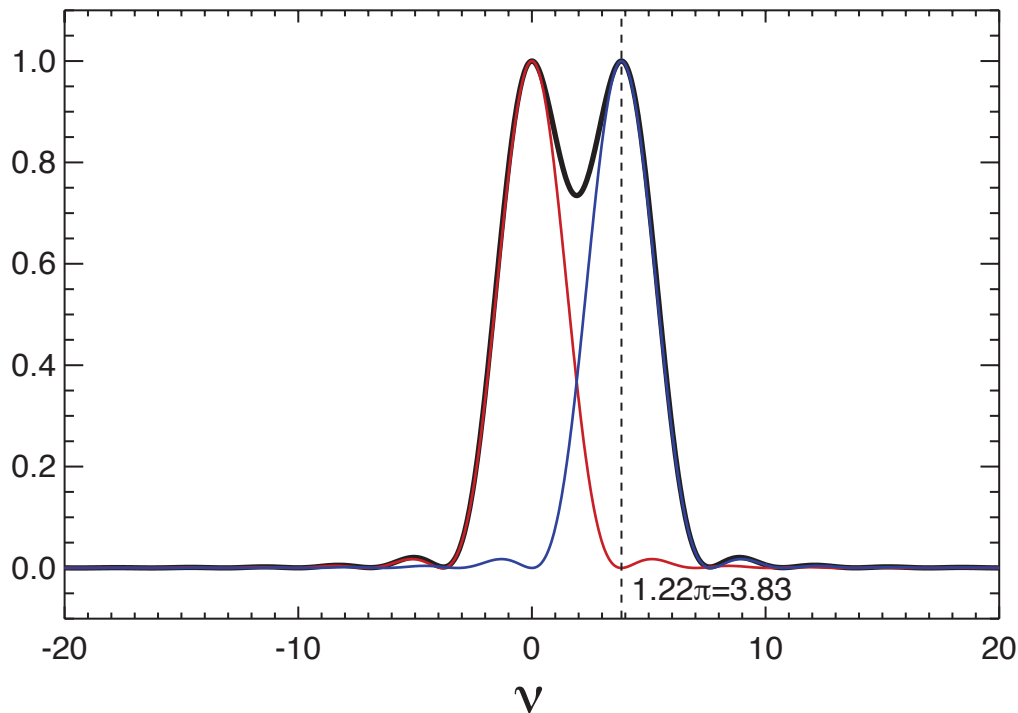
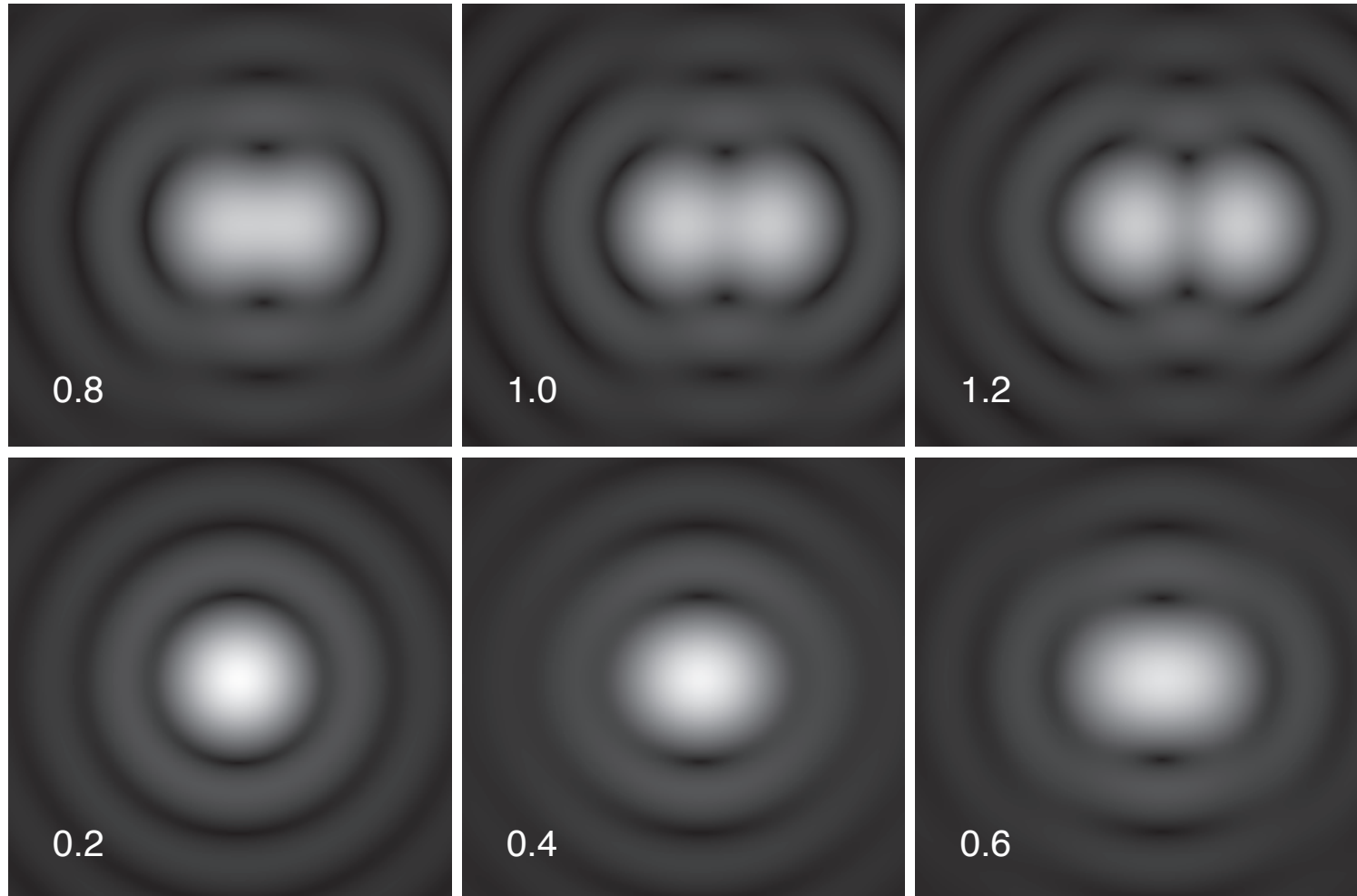

Illustration of Rayleigh resolution

- Separation of two spots as a fraction of the Rayleigh resolution



Modulation transfer function for incoherent brightfield

- Lens semi-angle θ ($NA=n\sin\theta$): $\theta=\lambda/d'$
- Coherent imaging cutoff at spatial frequency of $f_d=1/d'$
- Incoherent imaging goes to twice the spatial frequency, but with losses

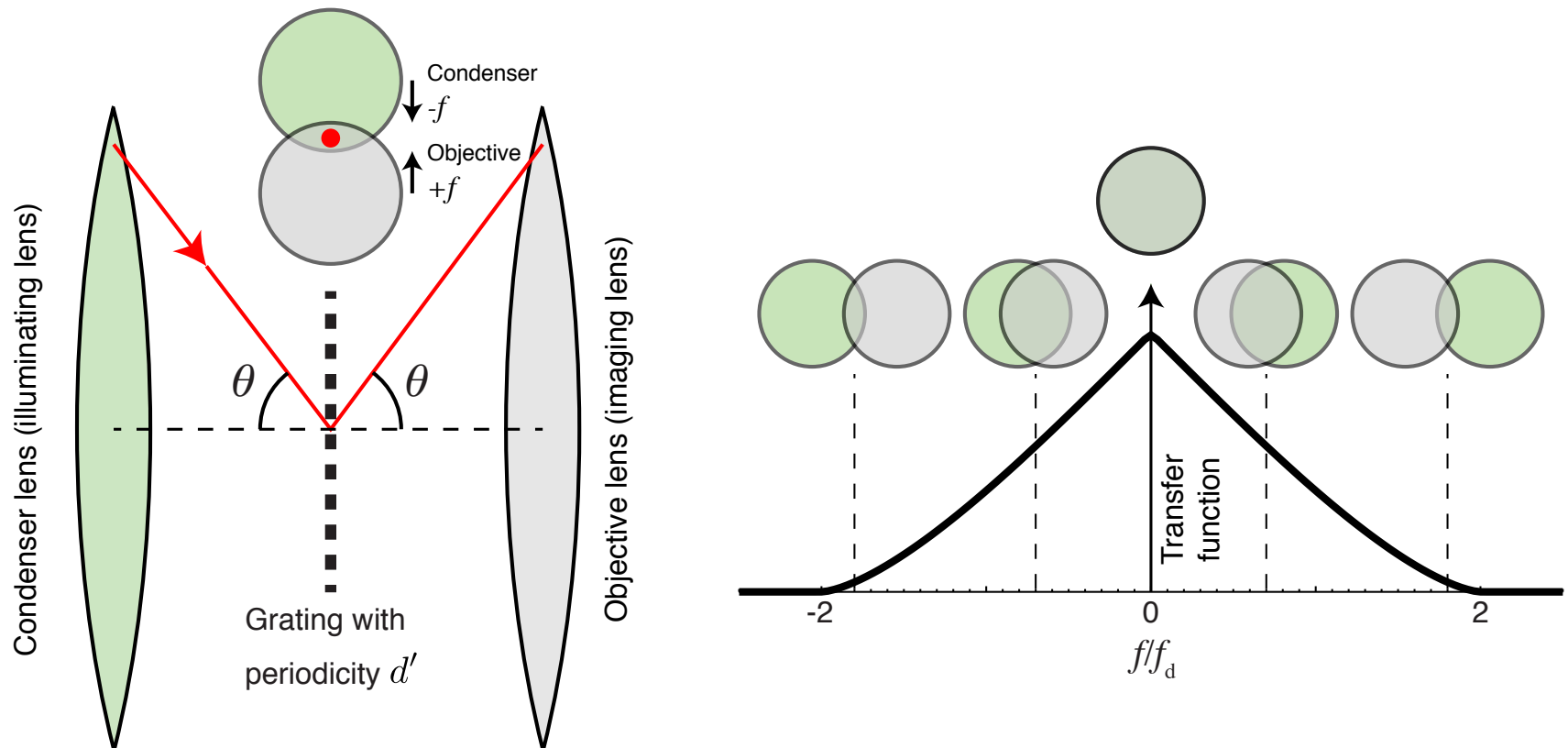

X-ray interaction cross sections

- There are no cloudy days for X rays!

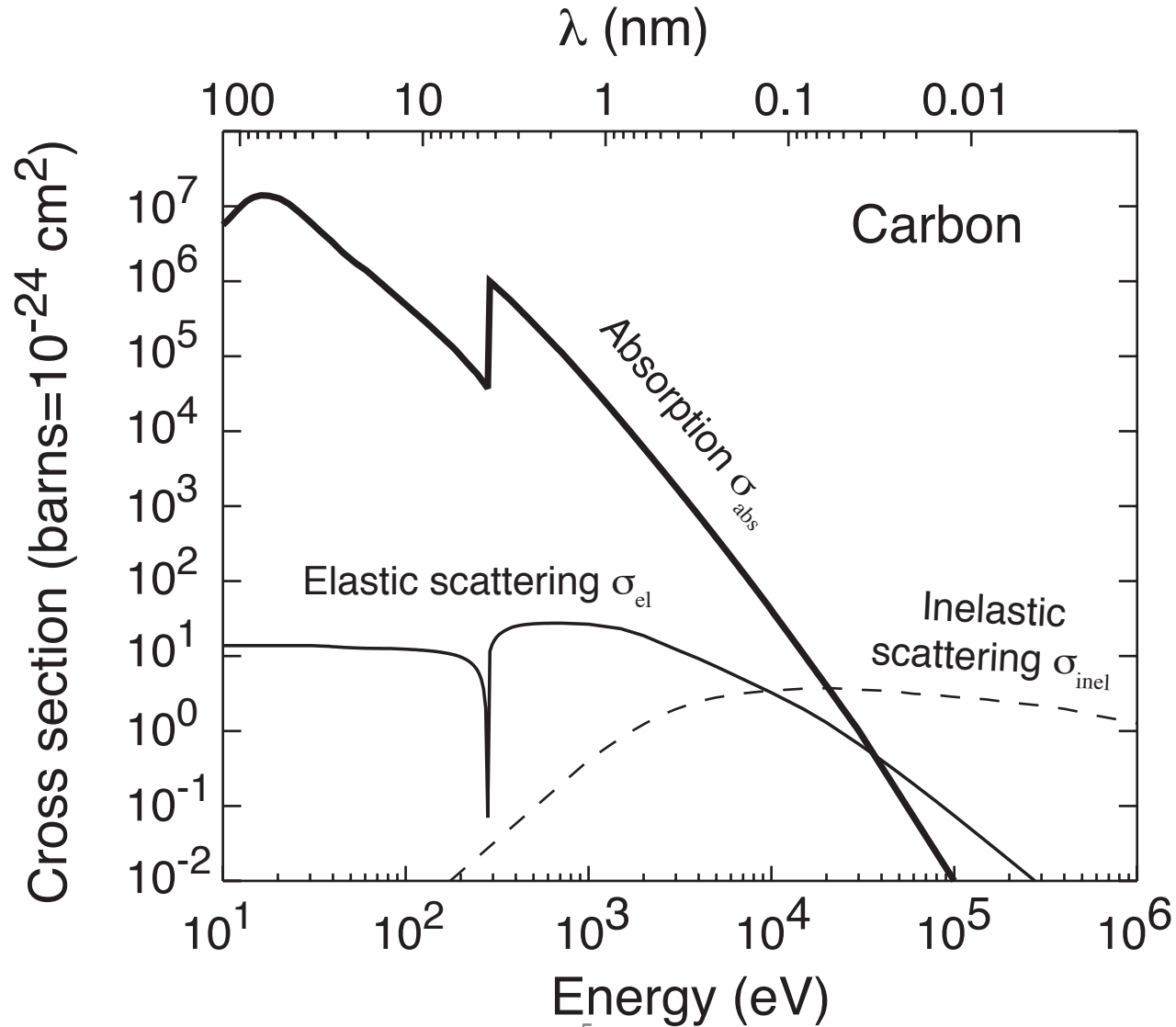

The refractive index

- Damped, driven harmonic oscillator

Driving frequency

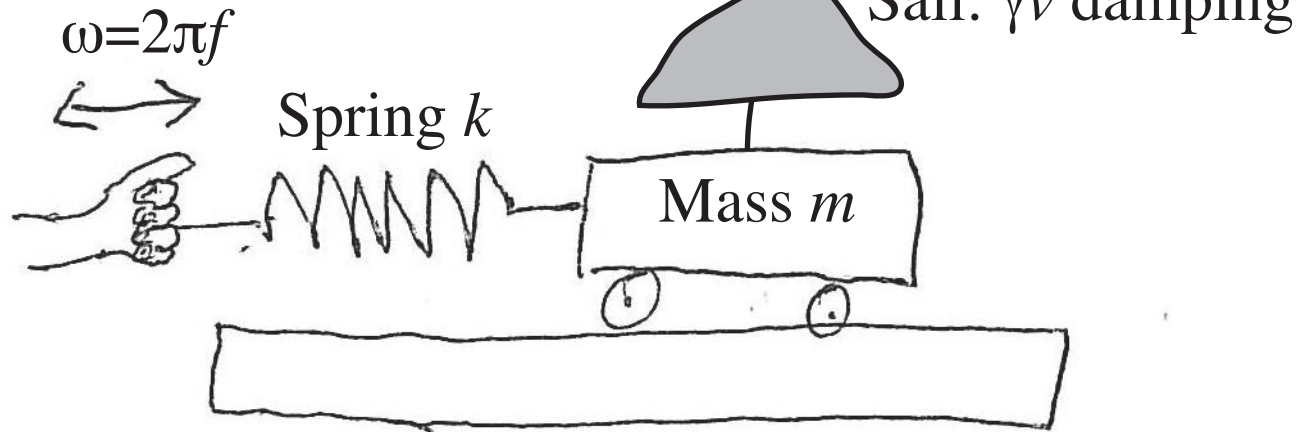

- D
- Driven: incident electromagnetic wave ω
- Harmonic oscillator: electronic quantum state with energy

$$\hbar\omega = \hbar\sqrt{k/m}$$

Damped, driven harmonic oscillator

- Single resonance: absorption peak, phase shift across resonance

$$Q = \omega_0 / \gamma$$

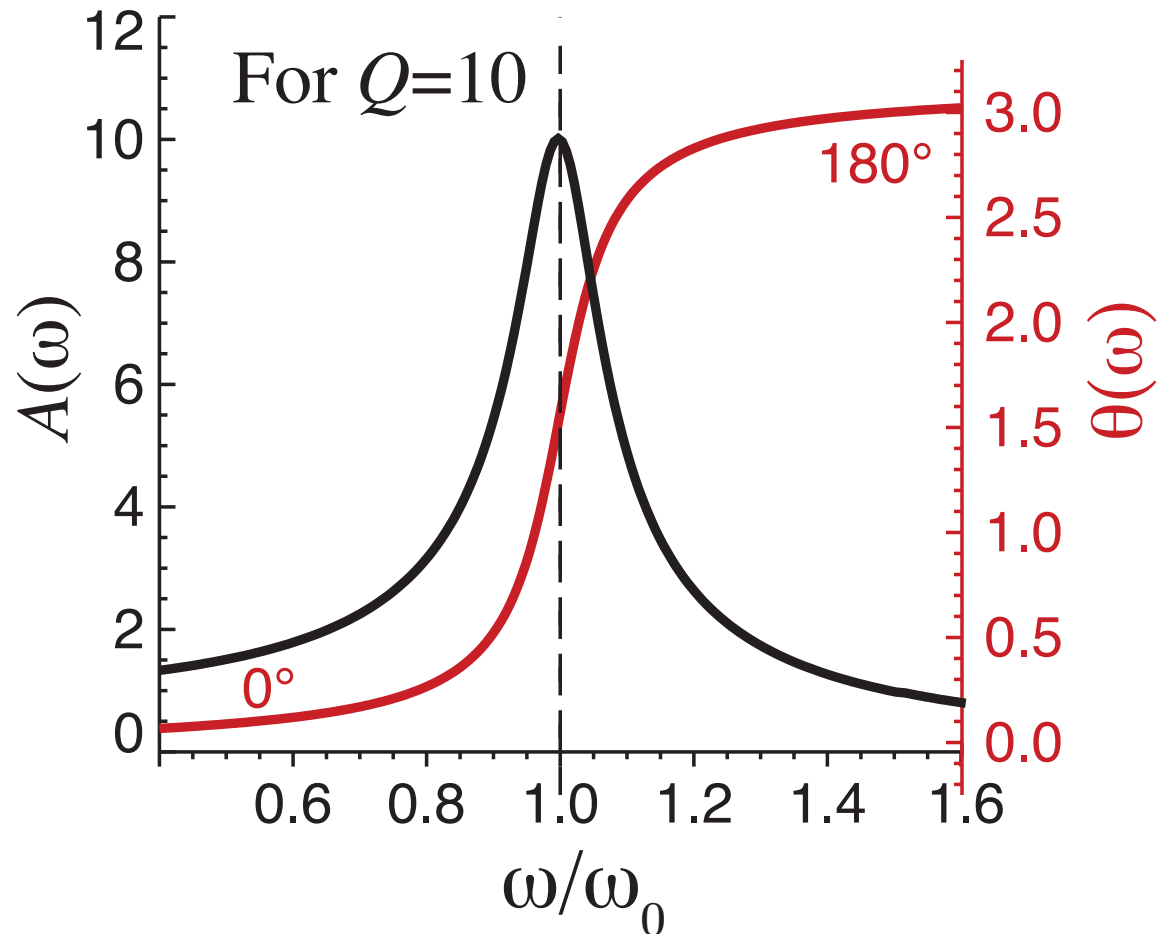

X-rays: the high frequency limit?

What's the dividing line between low and high frequency limits of refractive index? At what frequency are most of the oscillators?

Plasmon frequency

$$\omega_p = (4\pi c^2 n_a r_e)^{1/2}$$

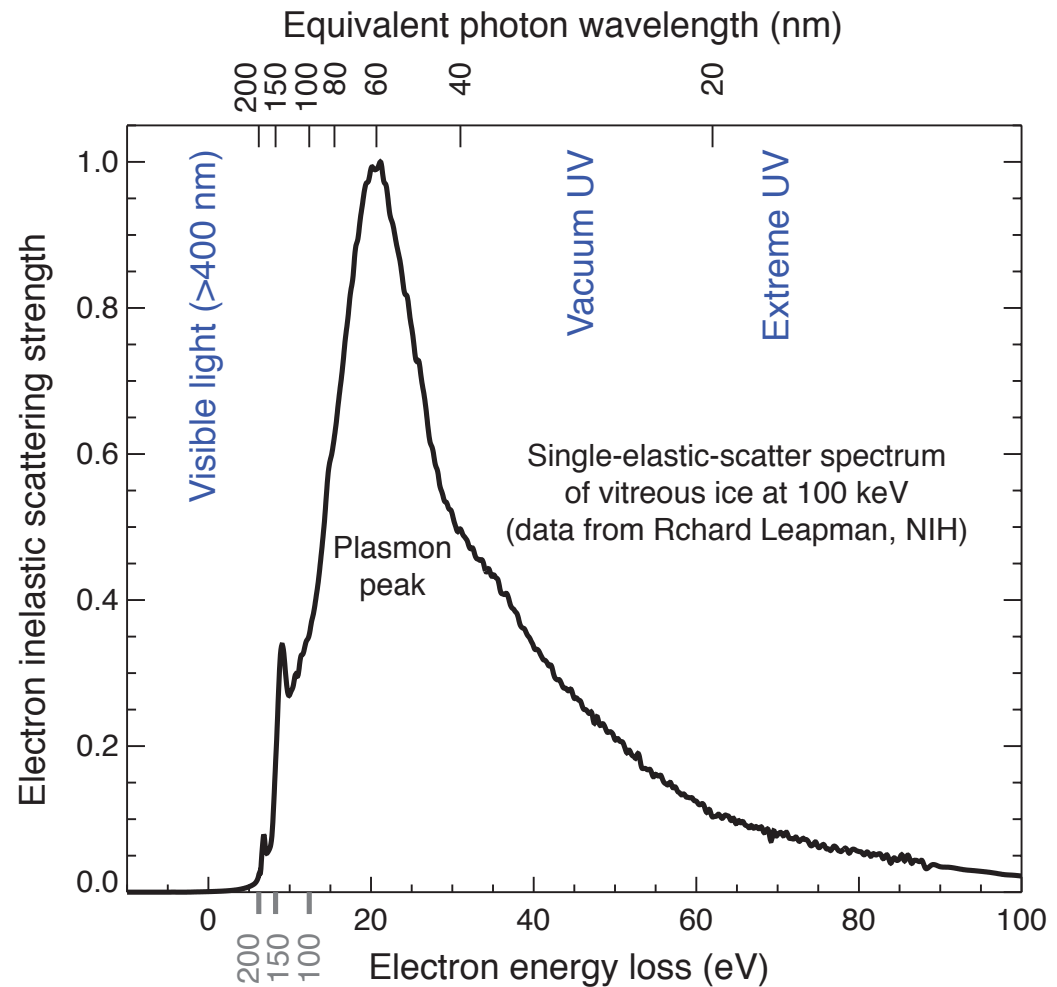

Mysteries of the x-ray refractive index

Write refractive index as

$$n = 1 - \frac{n_a r_e}{2\pi} \lambda^2 (f_1 + i f_2)$$
$$= 1 - \alpha \lambda^2 (f_1 + i f_2)$$

where $n_a = \#$ atoms/volume, and

$r_e = 2.818 \times 10^{-15}$ m is the classical radius of the electron. Assumes $\exp[-i(kx - \omega t)]$ for forward propagation.

Also written as $n = 1 - \delta - i\beta$

Phase velocity is

$$v_p = \frac{\omega}{k} \simeq c(1 + \alpha \lambda^2 f_1)$$

Group velocity is

$$v_g = \frac{d\omega}{dk} \simeq c(1 - \alpha \lambda^2 f_1)$$

86

A. Einstein,

[Nr. 9/12.

Lassen sich Brechungsexponenten der Körper für Röntgenstrahlen experimentell ermitteln?

Von A. Einstein.

(Eingegangen am 21. März 1918.)

Vor einigen Tagen erhielt ich von Herrn Prof. A. KÖHLER (Wiesbaden) eine kurze Arbeit¹⁾, in welcher eine auffallende Erscheinung bei Röntgenaufnahmen geschildert ist, die sich bisher nicht hat deuten lassen. Die reproduzierten Aufnahmen — zu meist menschliche Gliedmaßen darstellend — zeigen an der Kontur einen hellen Saum von etwa 1 mm Breite, in welchem die Platte heller bestrahlt zu sein scheint als in der (nicht beschatteten) Umgebung des Röntgenbildes.

Ich möchte die Fachgenossen auf diese Erscheinung hinweisen und beifügen, daß die Erscheinung wahrscheinlich auf Totalreflexion beruht. Nach der klassischen Dispersionstheorie müssen wir erwarten, daß der Brechungsexponent n für Röntgenstrahlen nahe an 1 liegt, aber im allgemeinen doch von 1 verschieden ist. n wird kleiner bzw. größer als 1 sein, je nachdem der Einfluß derjenigen Elektronen auf die Dispersion überwiegt, deren Eigenfrequenz kleiner oder größer ist als die Frequenz der Röntgenstrahlen. Die Schwierigkeit einer Bestimmung von n liegt darin, daß $(n - 1)$ sehr klein ist (etwa 10^{-5}). Es ist aber leicht einzusehen, daß bei nahezu streifender Inzidenz der Röntgenstrahlen im Falle $n < 1$ eine nachweisbare Totalreflexion auftreten muß.

X-ray refractive index

Refractive index of
 $n = 1 - \alpha \lambda^2 (f_1 + i f_2)$

Real part of oscillator strength f_1 tends towards atomic number Z

Imaginary part of oscillator strength f_2 declines as E^{-2}

Phase $\exp[-ink]$ is advanced relative to vacuum by $2\pi\alpha\lambda f_1$

Intensity is decreased as $\exp[-4\pi\alpha\lambda f_2]$

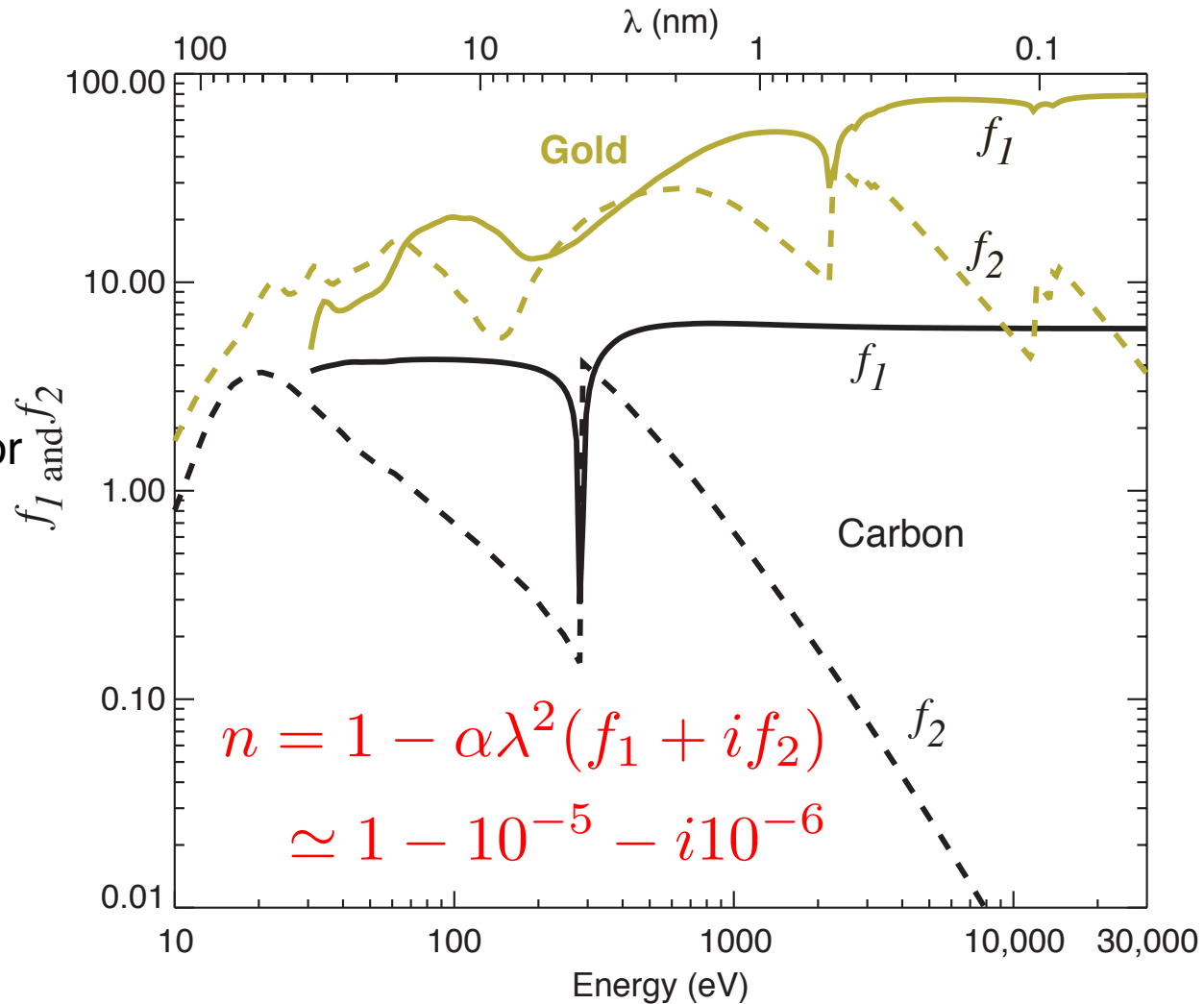

Data from http://henke.lbl.gov/optical_constants/

X rays in media

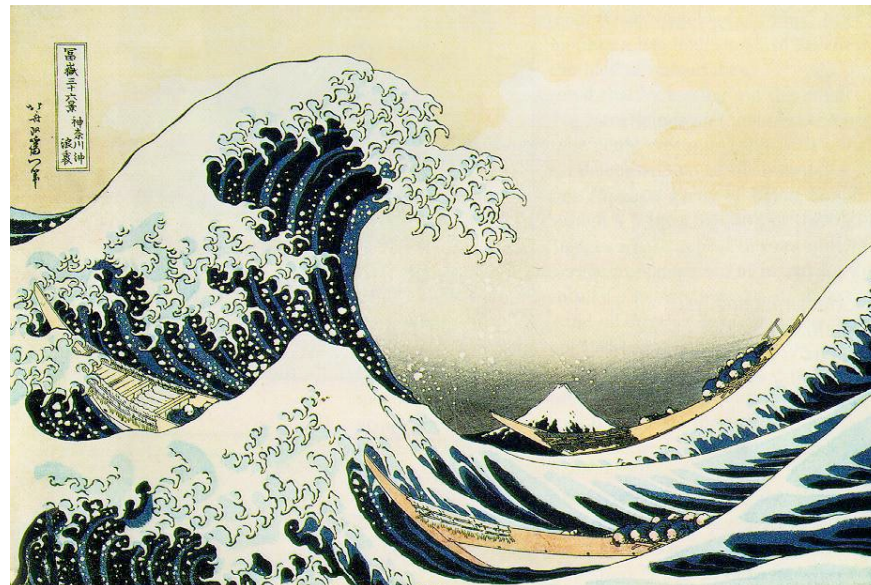
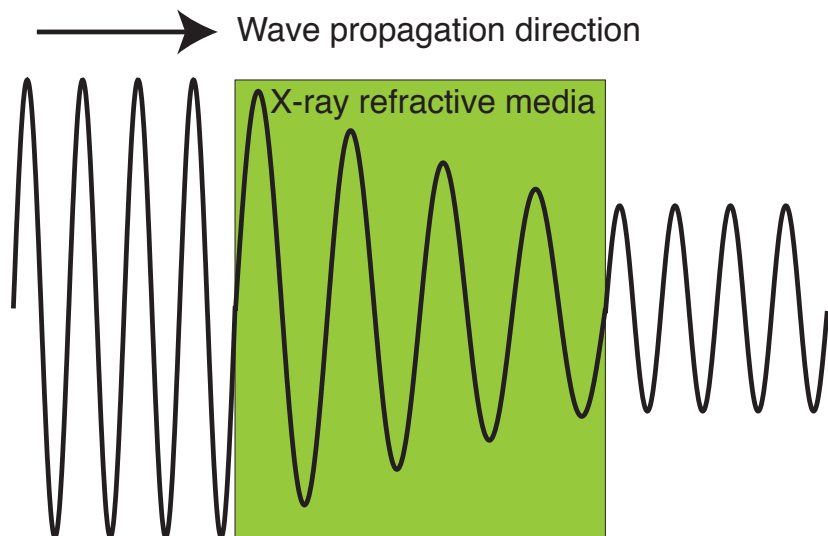

X-ray mirrors use total *internal* reflection!

- Total internal reflection happens when $\theta_1=90^\circ$ in $n_1\sin\theta_1=n_2\sin\theta_2$, or $\theta_2=\text{asin}(n_1/n_2)$.

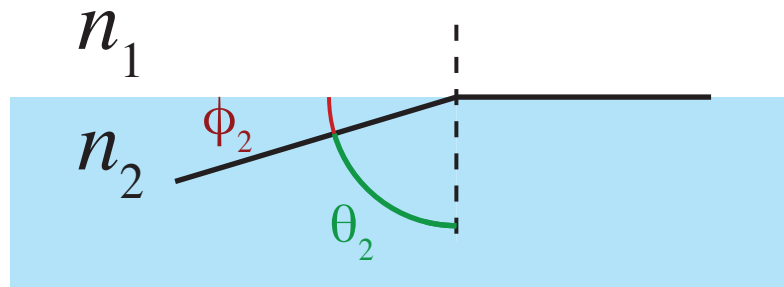
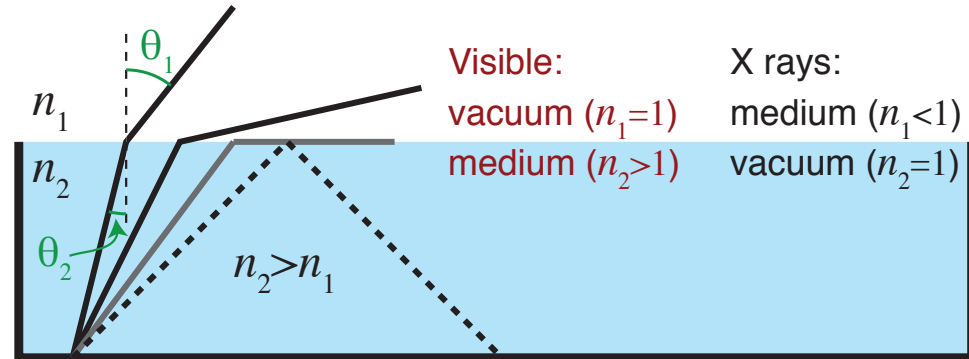
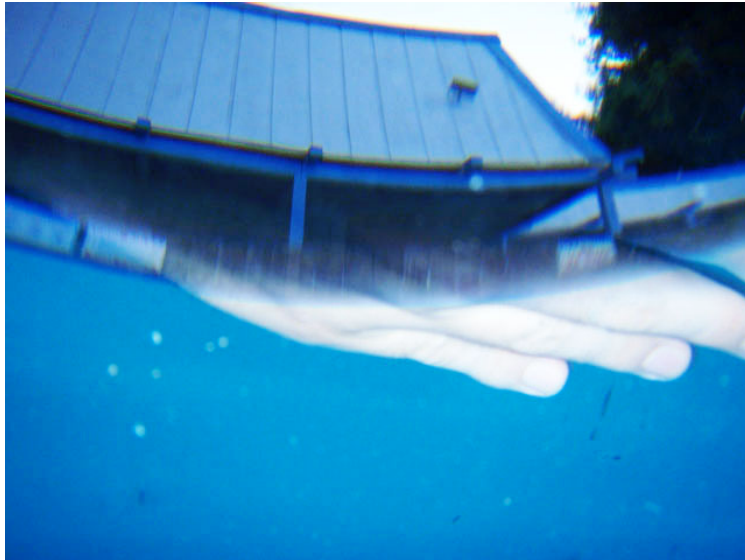

- Switch from angle θ_2 relative to normal incidence, to angle ϕ_2 relative to grazing incidence, or $\sin(\theta_2)=\cos(90^\circ-\phi_2)=\sin(\phi_2)$
- We then have $n_1=n_2\sin(\phi_2)$ or with $n_2=1$ and $\sin(\phi_2)\approx 1-(\phi_2)^2/2$ we have a **grazing incidence critical angle of $\phi_2 = \lambda(2\alpha f_1)^{1/2}$**
- Note diffraction resolution limit of ϕ_2/λ is (almost) independent of wavelength!

X-ray refraction

Larsson, Siegbahn, and Waller, *Naturwis.* **12**,
1212 (1924)

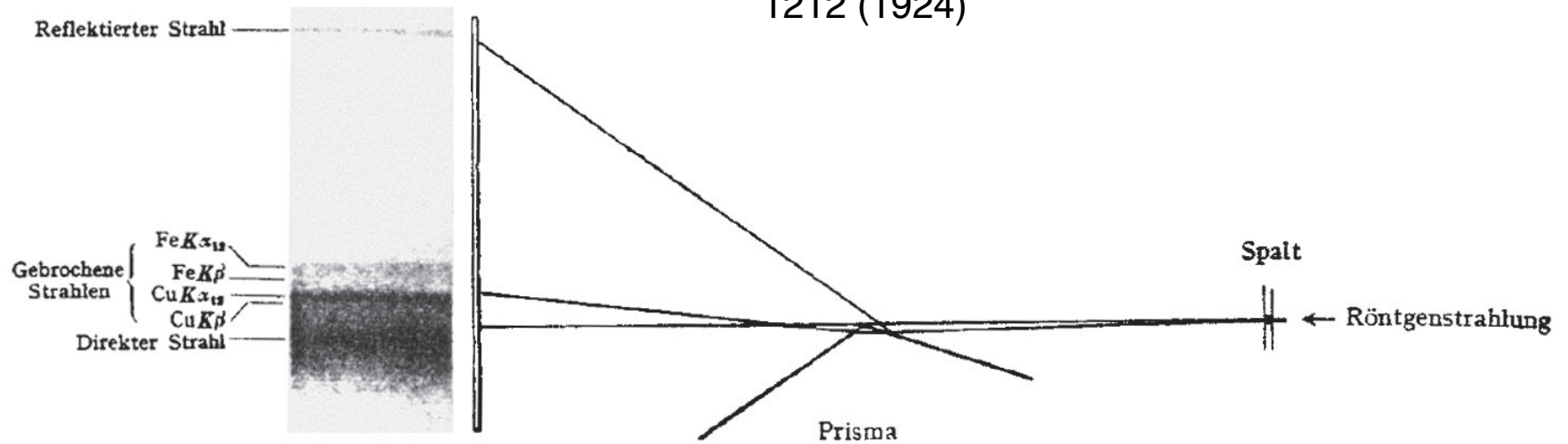

Paul Kirkpatrick and Albert Baez, 1948

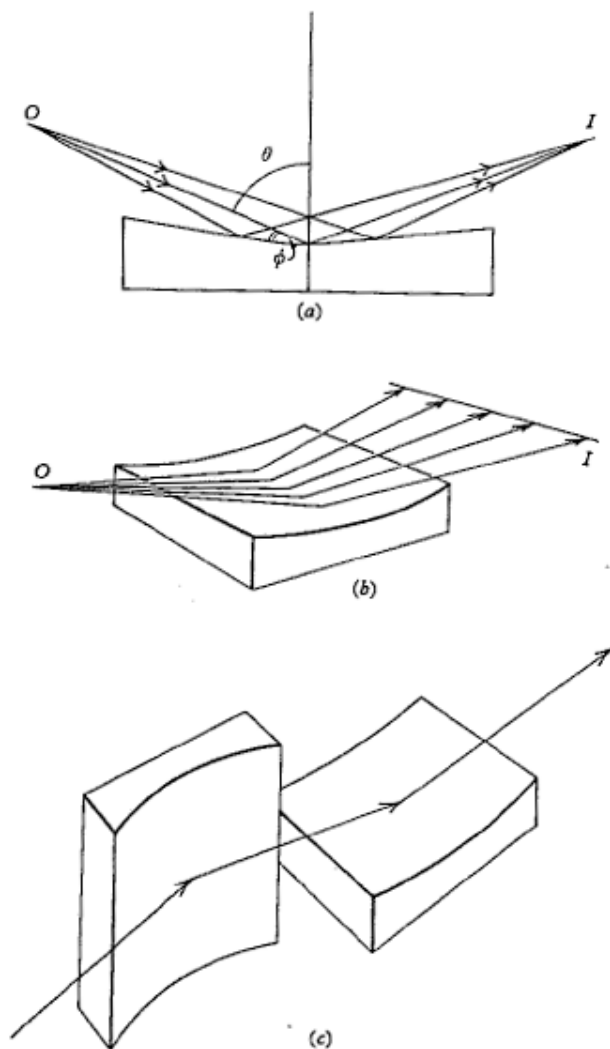

Fig. 1.2. Reflexion X-ray microscopy. (a) and (b) X-rays diverging from a source O are focused by a cylindrical surface to form an astigmatic image I ; (c) arrangement of two cylindrical mirrors for eliminating astigmatism. (Kirkpatrick & Pattee, 1953.)

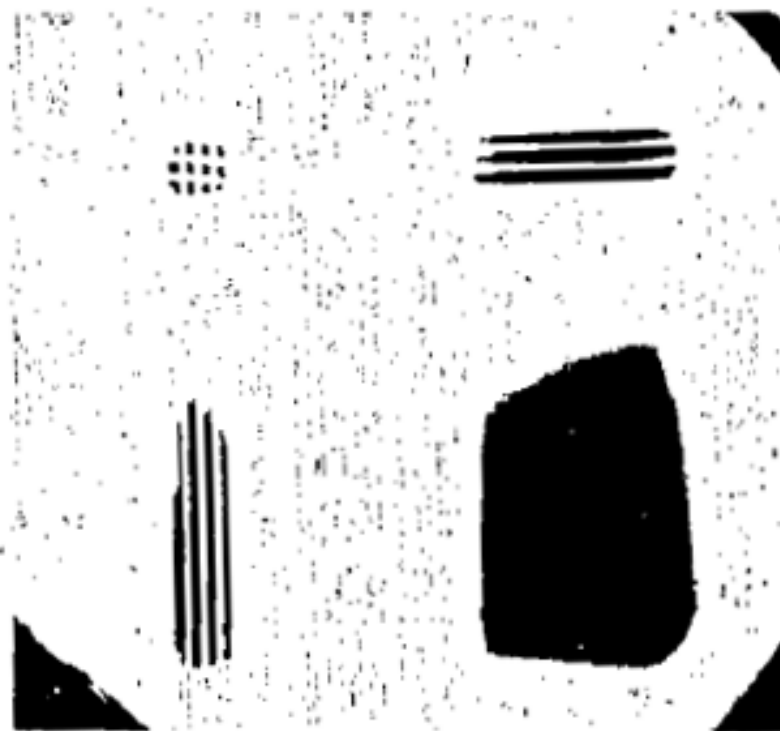

FIG. 12. Pattern produced by mirrors arranged as in Fig. 11. Object was a monel screen having 350 meshes per linear inch. In addition to the full image of the screen two partial images, each formed by one mirror, and a large spot caused by direct radiation appear above.

SCIENTIFIC AMERICAN

Established 1845

CONTENTS FOR MARCH 1949

VOLUME 180, NUMBER 3

SCIENTIFIC AMERICAN is copyrighted 1949 in the U. S. and Berne Convention countries by Scientific American, Inc.

THE X-RAY MICROSCOPE

by Paul Kirkpatrick

It would be a big improvement on microscopes using light or electrons, for X-rays combine short wavelengths, giving fine resolution, and penetration. The main problems standing in the way have now been solved. 44

Kirkpatrick and Pattee, 1953

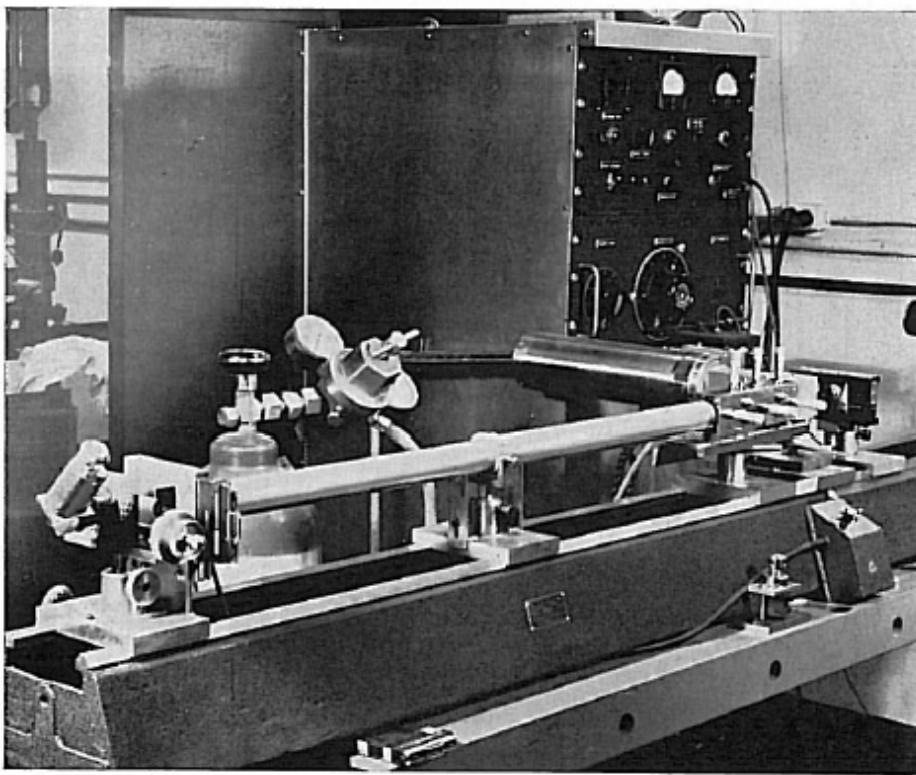

Reflexion X-ray microscope of Kirkpatrick and Pattee, incorporating two pairs of mirrors. (Kirkpatrick & Pattee, 1953.)

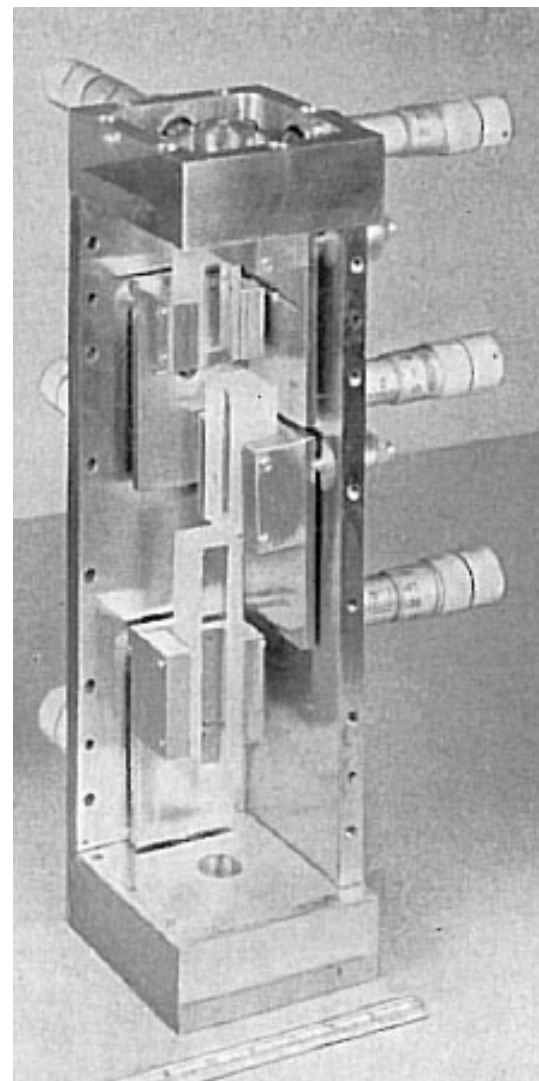

Nanofocusing with multilayer-coated KB mirrors

- da Silva, Pacureanu, Yang, Bohic, Morawe, Barrett, and Cloetens, *Optica* 4, 492 (2017)
- FWHM of 12.0 nm (H) and 12.6 nm (V) at 17 keV

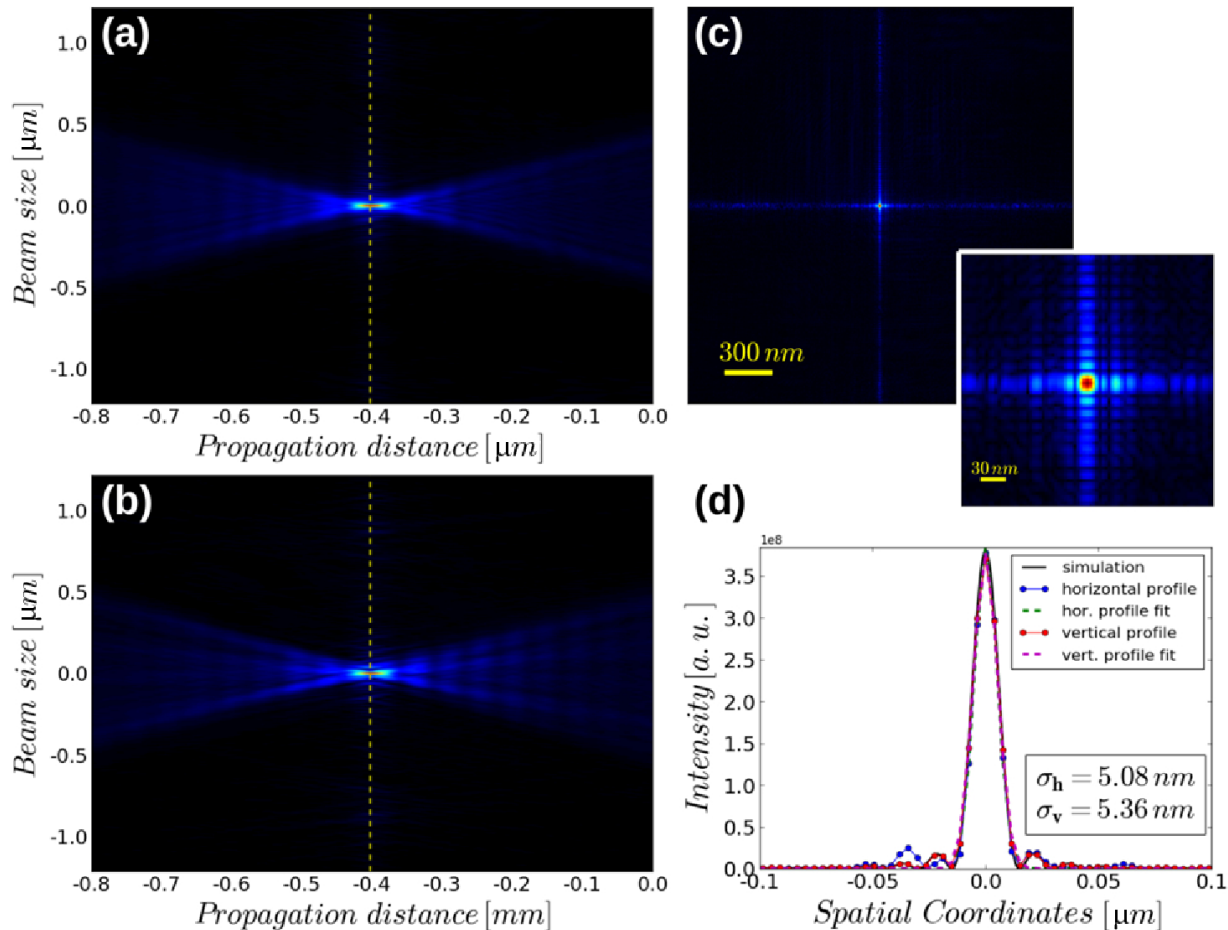

Compound refractive lenses

- Röntgen tried to make lenses, but found no focusing.
- Focal length of one lens is long – so combine many lenses! Tomie; Snigirev *et al.*, *Nature* **384**, 49 (1996); Lengeler *et al.*, *J. Synch. Rad.* **9**, 119 (2002).
- Resolution approaching 60 nm at 5-10 keV with parabolic beryllium lenses.
- Refractive lenses are especially good at 20 keV and higher.

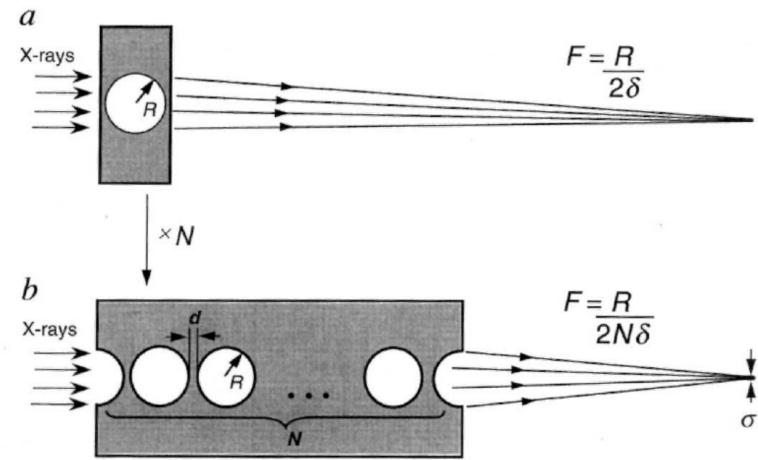

Compound refractive lenses at Universität Aachen

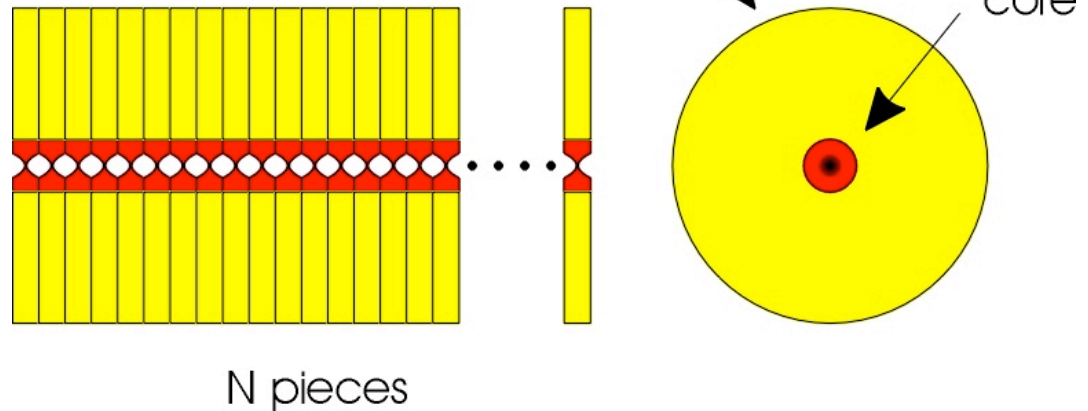

Diffractive focusing: Fresnel zone plates

- Fresnel zone construction: block out (or phase shift) every other $\lambda/2$
- Largest diffraction angle is given by outermost (finest) zone width dr_N as $\theta = \lambda / (2dr_N)$
- Rayleigh resolution is $0.61 \lambda / (\theta) = 1.22 dr_N$
- Zones must be positioned to $\sim 1/3$ width over diameter (10 nm in 100 μm , or $1:10^4$)
- Diameters tend to be $\sim 100 \mu\text{m}$, and focal lengths tend to be ~ 1 mm at 300 eV and few cm at 10 keV.

Diameter d , outermost zone width dr_N , focal length f , wavelength λ :

$$d dr_N = f \lambda$$

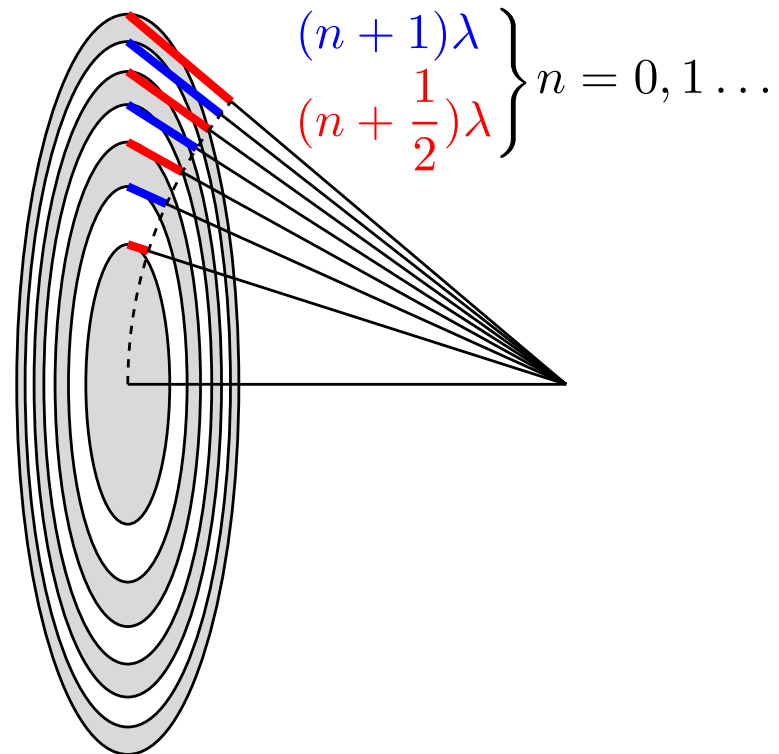

X-ray focusing: Fresnel zone plates

- Diffractive optics: radially varied grating spacing
- Largest diffraction angle is given by outermost (finest) zone width dr_N as $\theta = \lambda / (2dr_N)$
- Rayleigh resolution is $0.61 \lambda / (\theta) = 1.22 dr_N$
- Zones must be positioned to $\sim 1/3$ width over diameter (10 nm in 100 μm , or 1:10⁴)
- Diameters tend to be $\sim 100 \mu\text{m}$, and focal lengths tend to be $\sim 1 \text{ mm}$ at 300 eV and few cm at 10 keV.

Diameter d , outermost zone width dr_N ,
focal length f , wavelength λ :

$$d dr_N = f \lambda$$

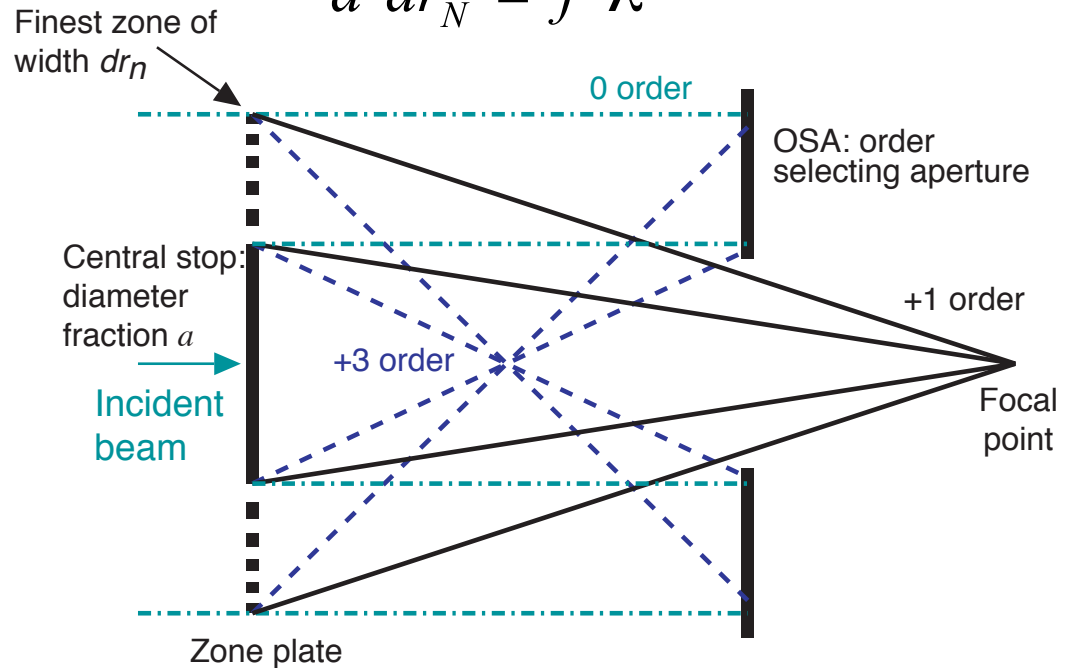

Central stop and order sorting aperture (OSA) to isolate first order focus

Zone plate efficiency and thickness

For binary zones, 1:1 mark:space ratio.
See Kirz, *J. Opt. Soc. Am.* **64**, 301 (1974)

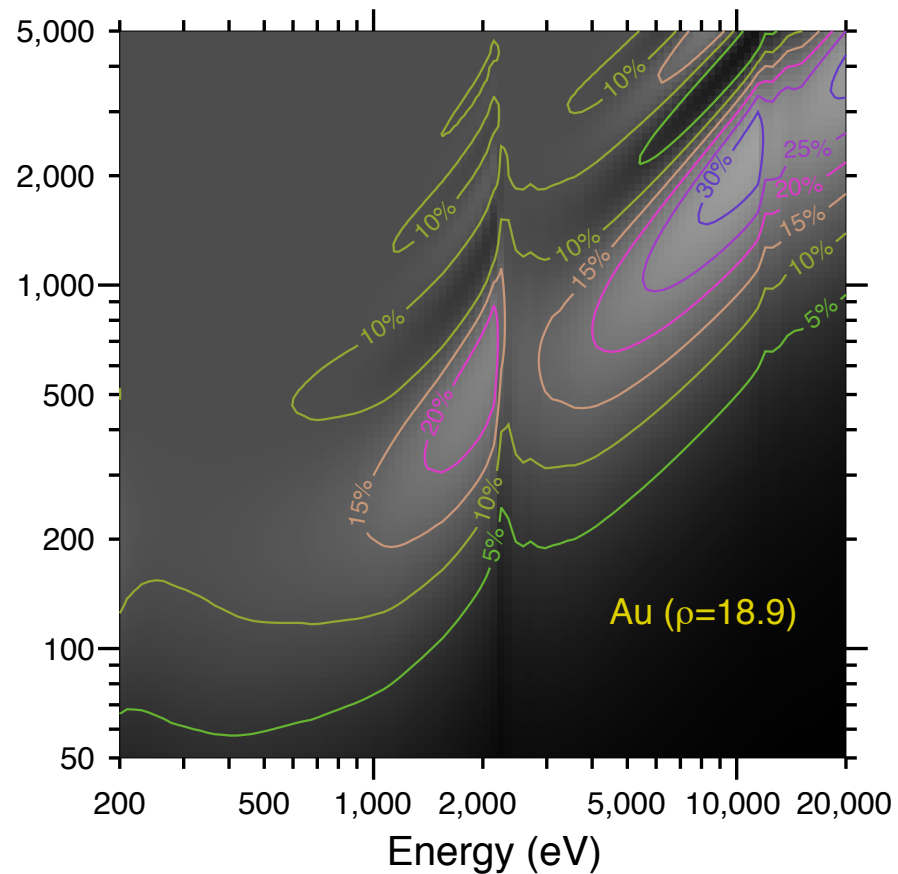
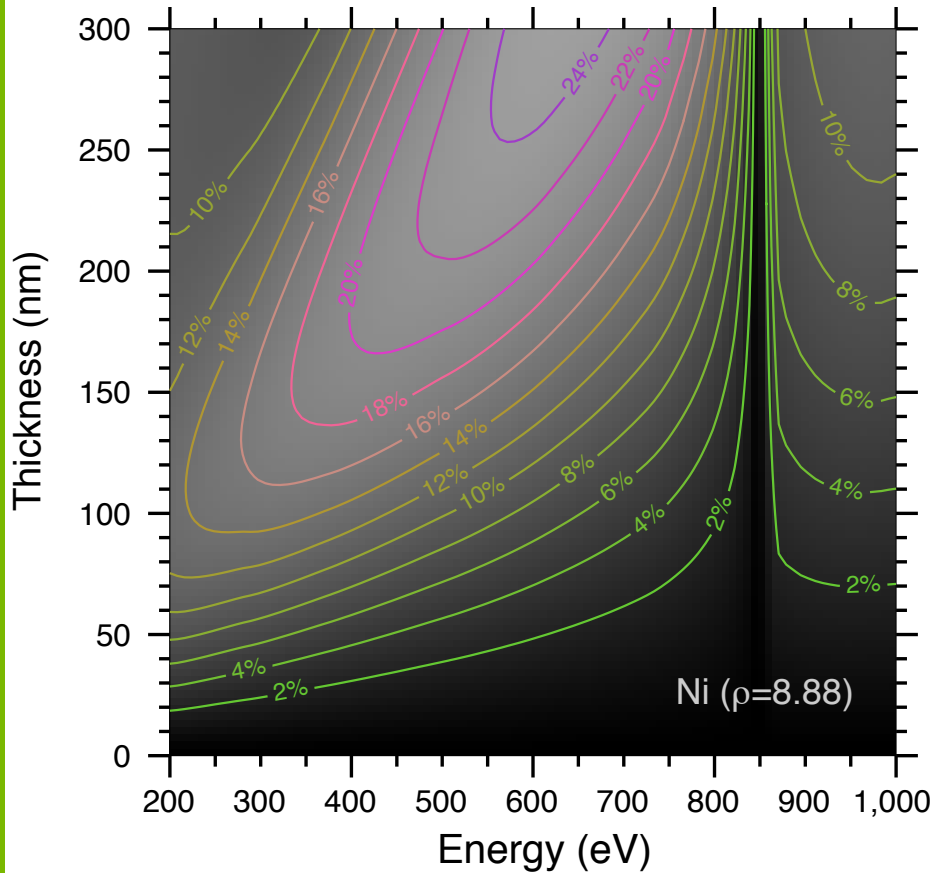

Zone plates by electron beam lithography

- Electron beam lithography: produces the finest possible structures (other than what nature can be persuaded to make by itself)
 - Example: JEOL JBX-9300FS: 1 nA into 4 nm spot, 1.2 nm over 500 μm , 100 keV
- Electrons scatter within resist, so highest resolution is only within ~ 100 nm thickness.
- Use directional etching methods like reactive ion etching for thick structures

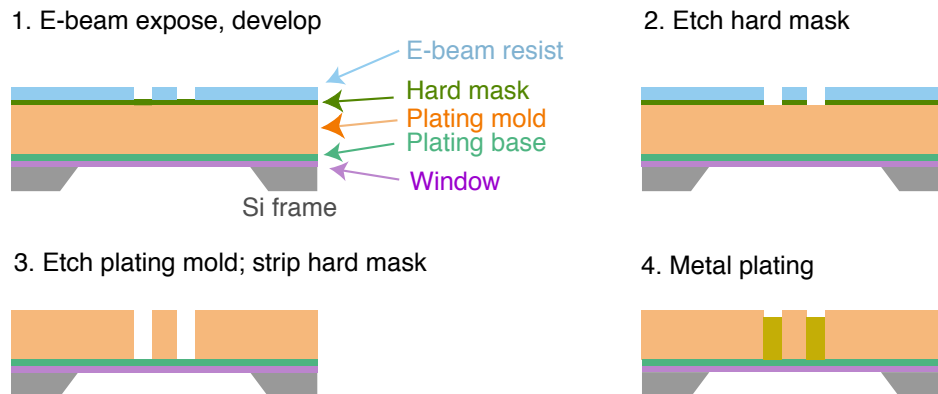

A. Stein and JBX-9300FS

Improving single zone plates: zone doubling

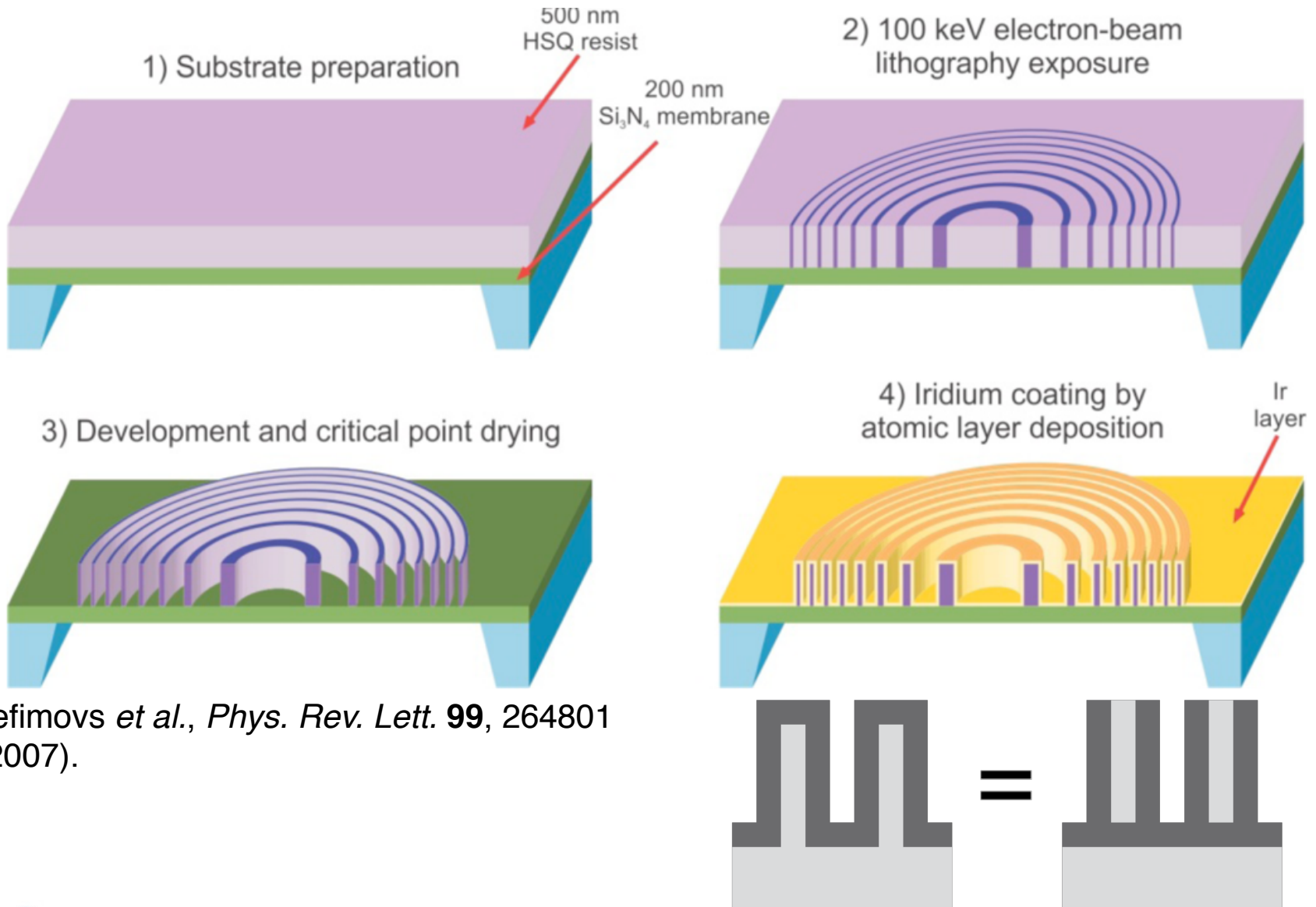

Fresnel zone plates for x-ray nanofocusing

14 nm zone width in Pt, up to 8 μm tall (aspect ratio=500). 6% efficient at 20 keV in preliminary tests; resolution tests underway.

Kenan Li, M. Wojcik, R. Divan, L. Ocola, B. Shi, D. Rosenmann, and C. Jacobsen, *J. Vac. Sci. Tech. B* (Nov. 2017)

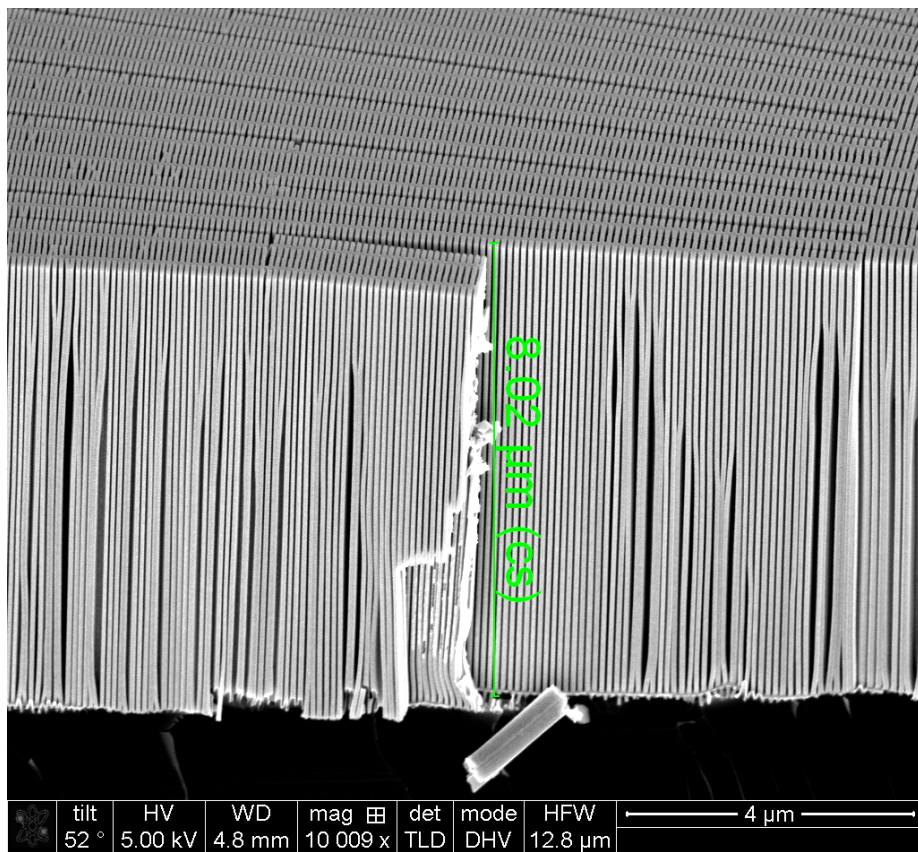

Metal-assisted chemical etching of silicon and atomic layer deposition to produce Pt zones. 14 nm wide zones that are 8 μm tall! Aspect ratio >500

62.5 nm (s)

13.8 nm (s)

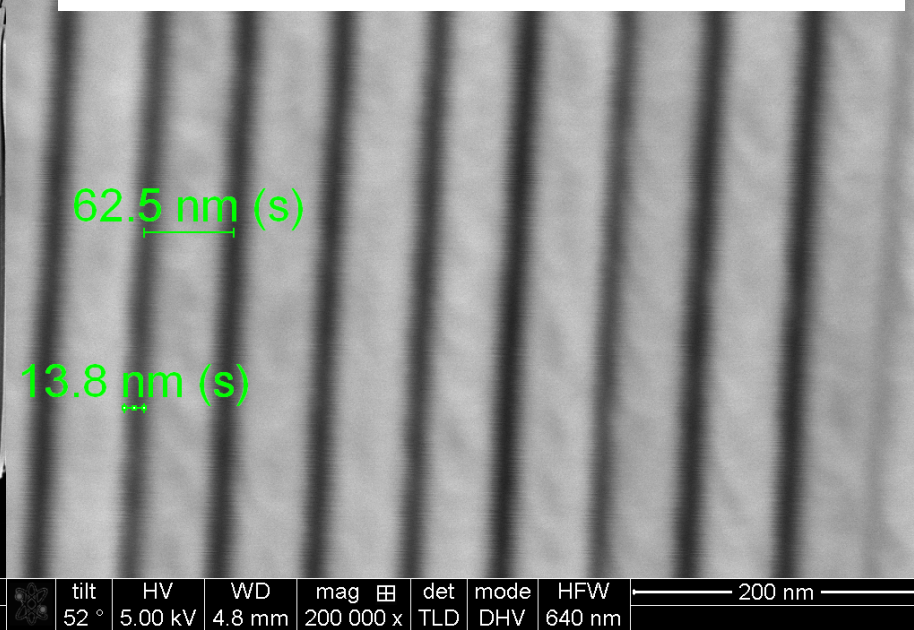

Recent APS/CNM/NU results: off the charts, on a log scale!

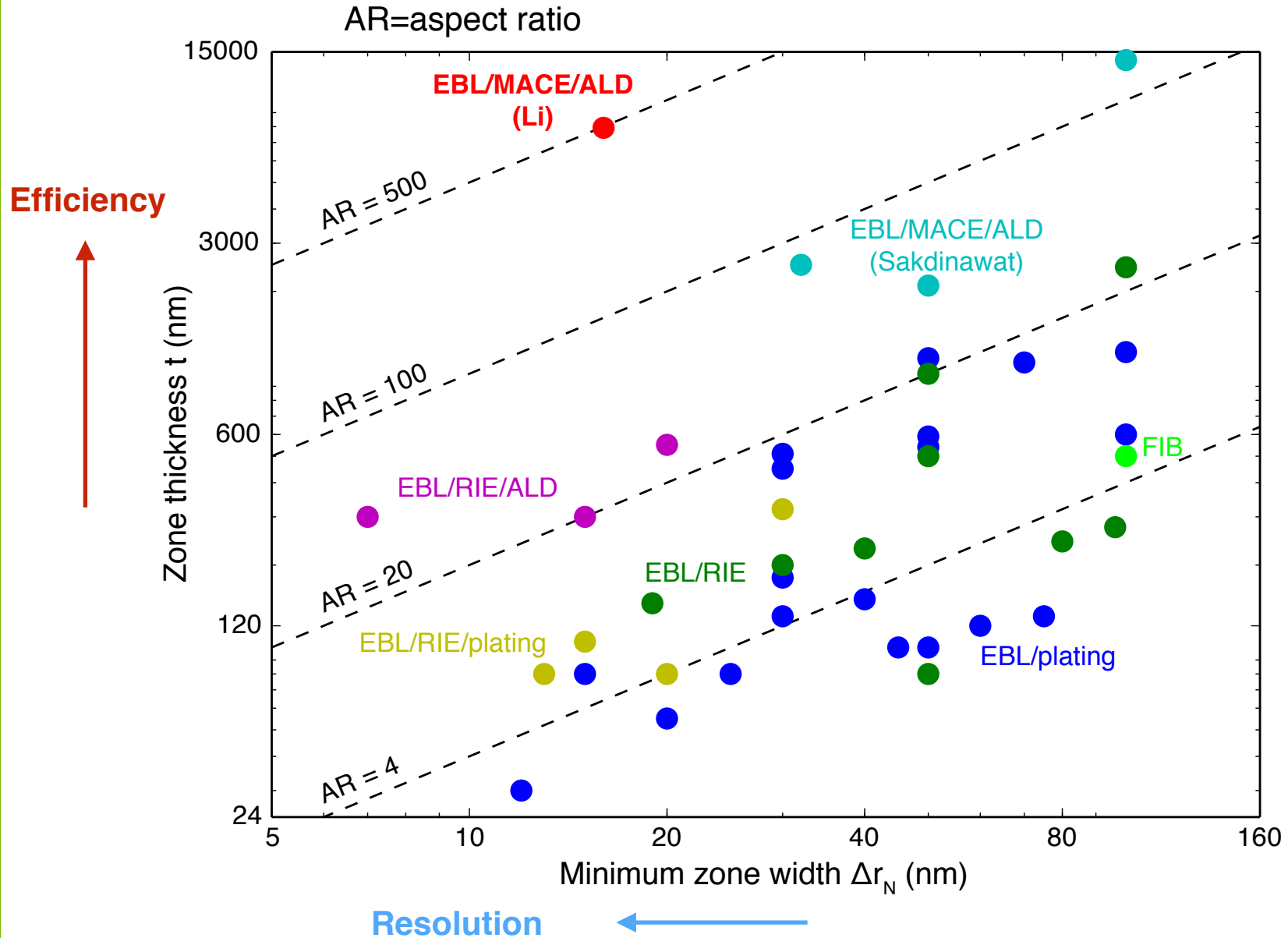

X-ray nanofocusing approaches are improving

- Visible light microscopy: better than 30 nm using centroid of sparse/switchable emitters
- Electron microscopy: aberration-corrected microscopes reach below 0.1 nm resolution
- X-ray microscopy: reaching 10 nm resolution for demonstrations on robust samples

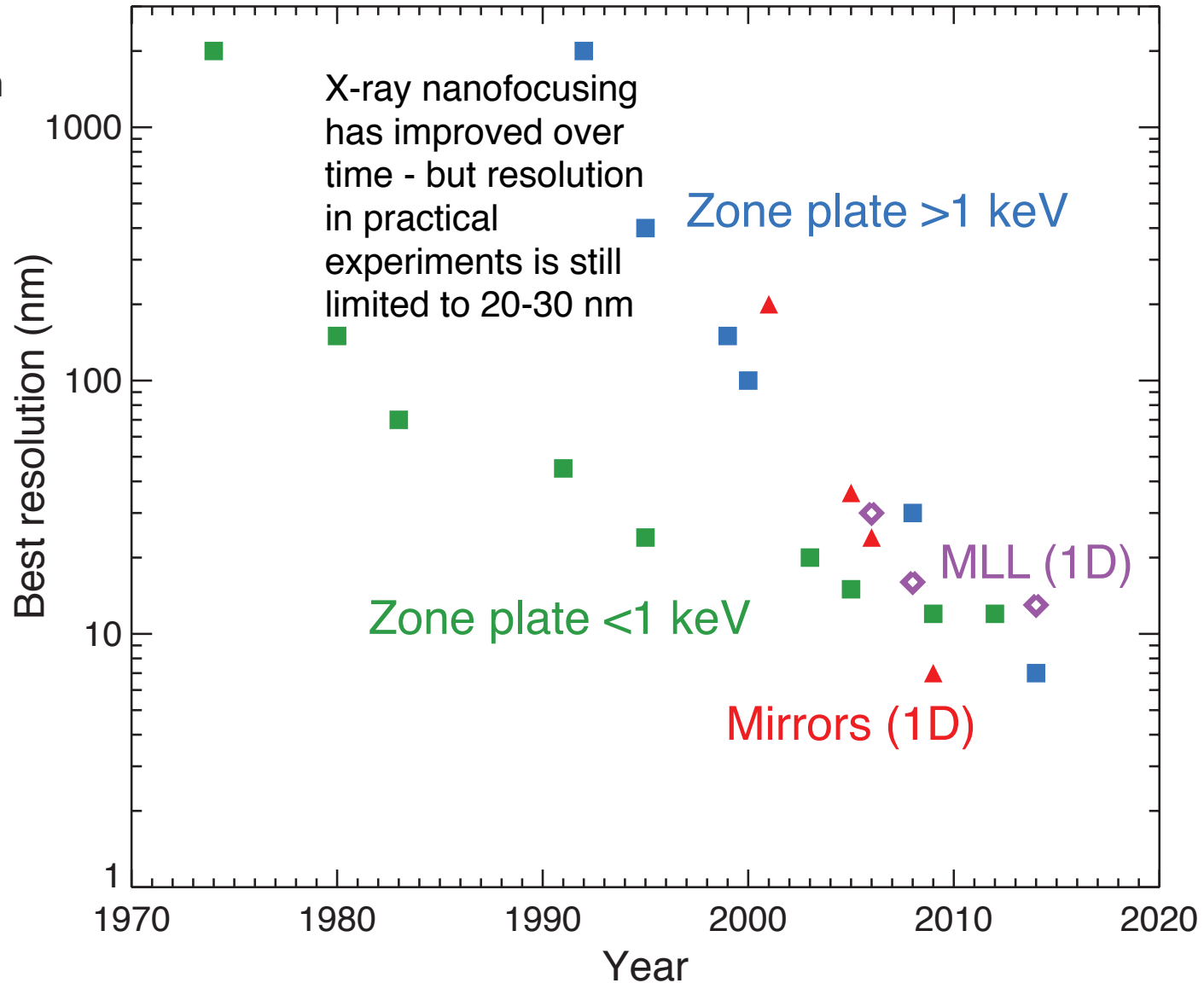

Zone plate microscopes

Full-field: transmission x-ray microscope (TXM)

- Incoherent illumination; works well with a bending magnet or a laboratory source
- Inefficient zone plate is *after* the sample (higher radiation dose)
- Faster (pixels in parallel)
- If zone plate condensers are used as monochromators, poor spectral resolution
- Transmission or reflection imaging

TXM: transmission x-ray microscope

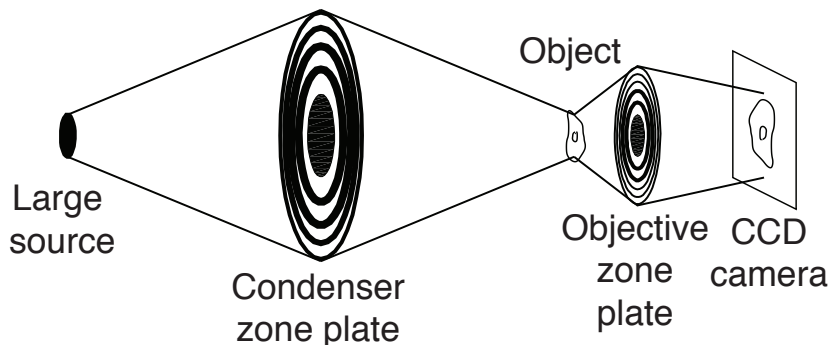

Scanning transmission x-ray microscope (STXM)

- Coherent illumination; works best with an undulator
- Inefficient zone plate is *before* the sample (lower radiation dose)
- Slower (pixels one-by-one)
- Unlimited field of view and magnification (scanning stages)
- Better suited to high resolution monochromators
- Flexible modalities: fluorescence etc.

STXM: scanning transmission x-ray microscope

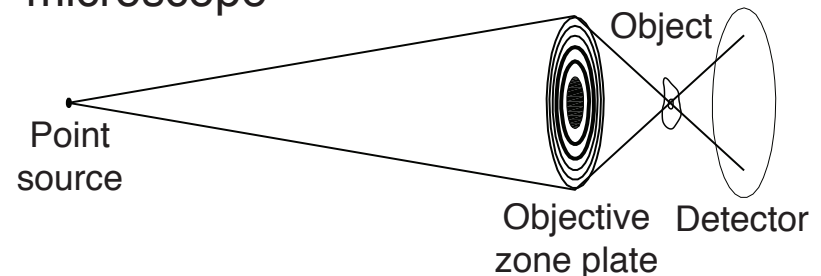

Nanofocusing requires coherent illumination

- Full-width, full-angle phase space of a diffraction limited lens with numerical aperture θ : $(2\theta) \cdot (2 \cdot 0.61\lambda / \theta) = 2.44\lambda$
- Thus need to limit source phase space to $\sim\lambda$ both in x and y

Illumination source

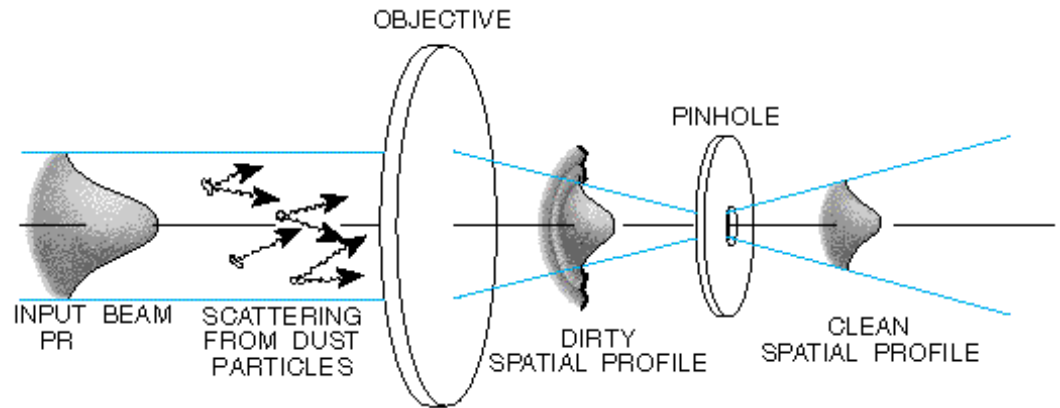

Image: demagnified source, plus aperture diffraction



Controlling spatial coherence

- Spatial filter: pinhole at the focus of a lens. Passes only the spatially coherent fraction of an incident beam.
- X-ray beamlines: image the source to a secondary position with an aperture, for a flux-versus-coherence tradeoff.



Diagram, photo from Newport catalog

Phase space area and probe focus

How close must $p=(\text{source diameter})\cdot(\text{optic's full subtended angle})$ be to λ ? $p \approx 1 \cdot \lambda$ works pretty well!

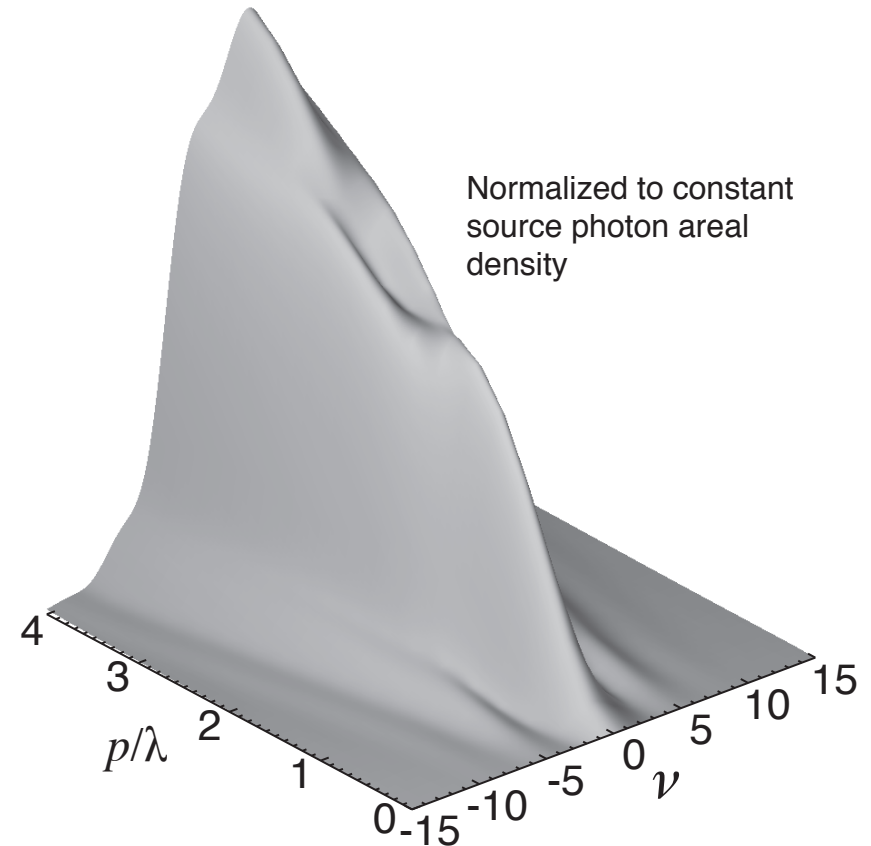
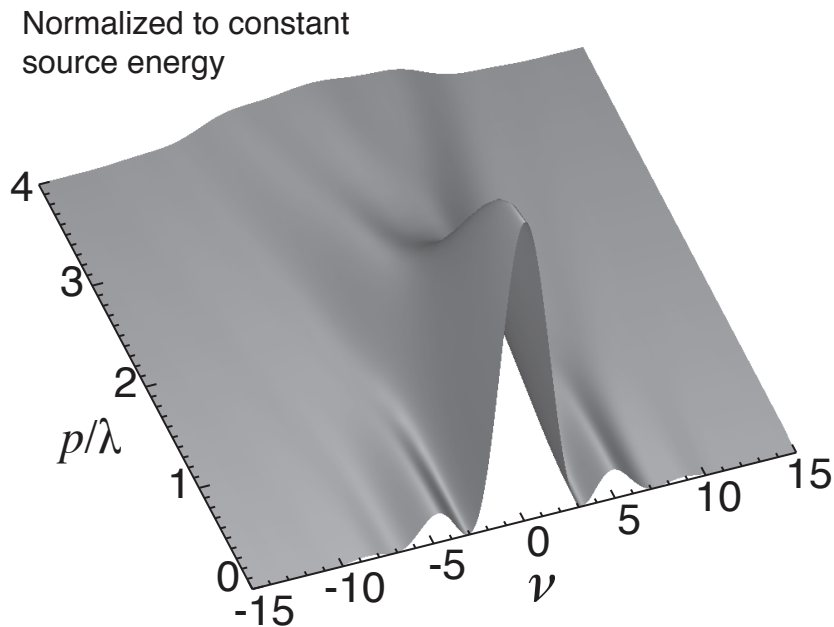

Effect on point spread function PSF (50% central stop)

Jacobsen *et al.*, *Ultramicroscopy* **47**, 55 (1992); Winn *et al.*, *J. Synch. Rad.* **7**, 395 (2000).

2D imaging with Stony Brook STXMs

2D imaging is moderately useful but...

- Cannot track fluorescently-labeled proteins in living cells
- Resolution is inferior to cryoEM, though do not need to section
- Best utility may lie beyond simple 2D imaging

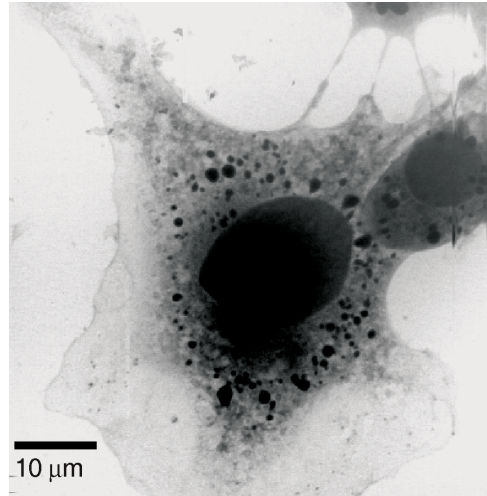

NIL 8 fibroblast (wet, fixed): Oehler *et al.*



Human sperm (unfixed): Wirick, Fleckenstein, Sheynkin *et al.*

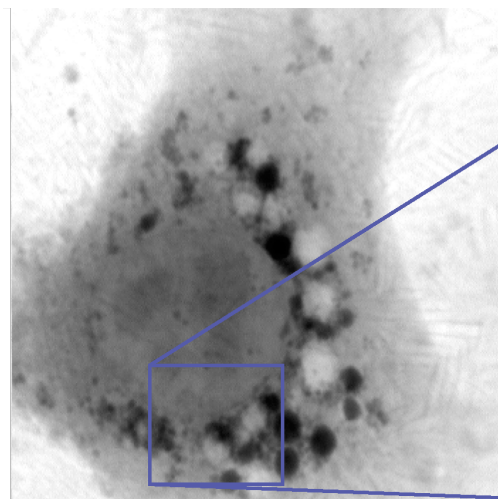

7 μm

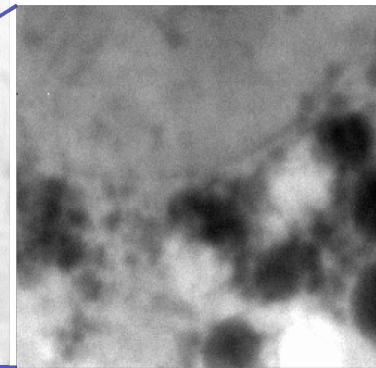

2 μm

Fibroblast (frozen hydrated): Maser *et al.*, *J. Microsc.* **197**, 68 (2000)



Energy scales

- Chemistry: C-H bond is 104 kcal/mol or 435 kJoules/mol:

$$\left(435 \frac{\text{kJ}}{\text{mol}}\right) \cdot \left(\frac{10^3 \text{ J}}{\text{kJ}}\right) \cdot \left(\frac{1 \text{ eV}}{1.602 \times 10^{-19} \text{ J}}\right) \cdot \left(\frac{1}{6.02 \times 10^{23} \text{ molecules/mol}}\right)$$

or $E=4.5$ eV/molecule.

- Photon wavelength associated with 4.5 eV is

$$E = \frac{hc}{\lambda} = \frac{1240 \text{ eV} \cdot \text{nm}}{\lambda}$$

or $\lambda=275$ nm.

- More broadly, chemical bonds involve 300-900 kJ/mol, or 3-9 eV/ molecule, or 130-400 nm light.
- Bohr model:

$$E = -E_0 \frac{Z^2}{n^2} = -13.6 \text{ eV} \frac{Z^2}{n^2}$$

Absorption edges

Lambert-Beer law: linear absorption coefficient μ

$$I = I_0 e^{-\mu(E) \cdot t} = I_0 e^{-D(E)}$$

This coefficient makes a jump at specific elemental absorption edges!

This example: 0.1 μm protein in water

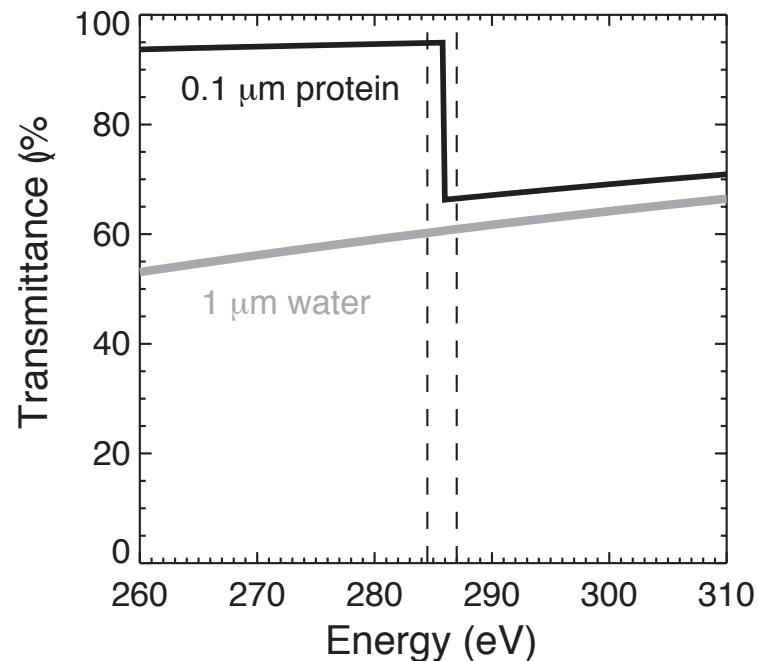
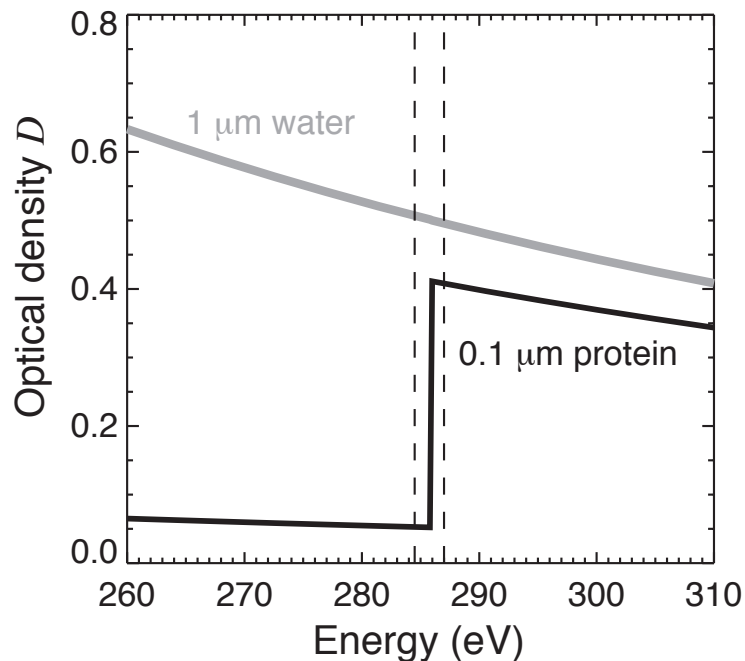
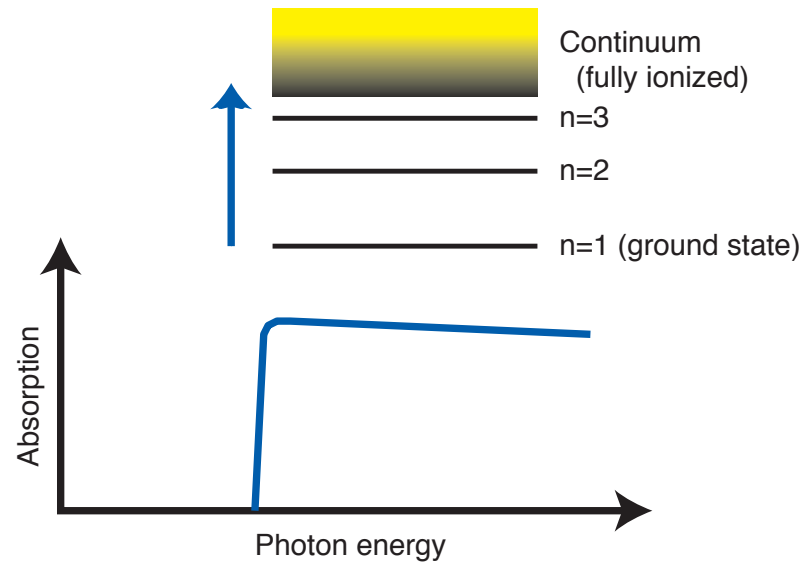

X-ray microscopy of colloids

- U. Neuhäusler (Stony Brook/Göttingen), S. Abend (Kiel), G. Lagaly (Kiel), C. Jacobsen (Stony Brook), *Colloid and Polymer Science* **277**, 719 (1999).
- Emulsion: water, oil droplets, clay, and layered double hydroxides (LDH).
- “Caged” part of oil droplet remains fixed; “uncaged” part can disperse.

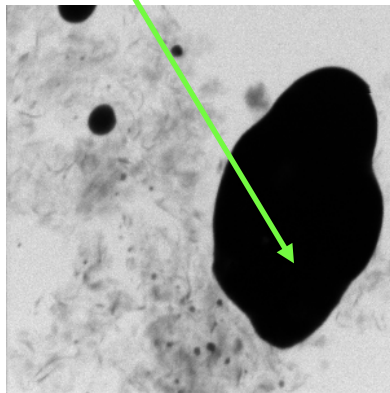

4 microns

346 eV: calcium weakly absorbing. Clays and LDHs absorb equally

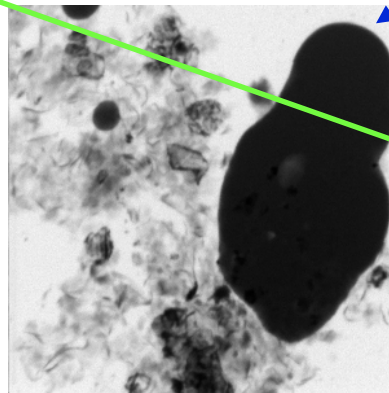

4 microns

352.3 eV: calcium strongly absorbing. Calcium-rich LDHs are highlighted.

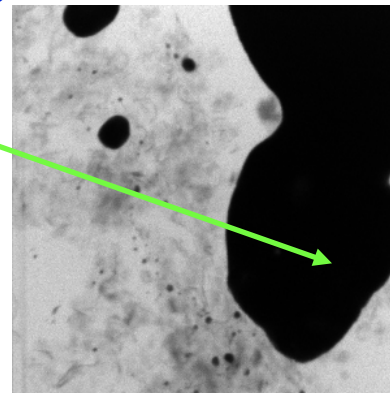

4 microns

290 eV: carbon strongly absorbing

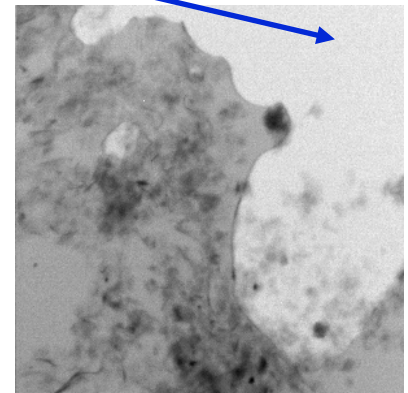

4 microns

284 eV: carbon (oil drop) weakly absorbing

Near-edge absorption fine structure (NEXAFS) or

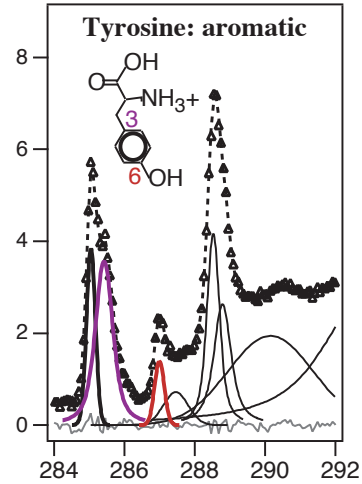
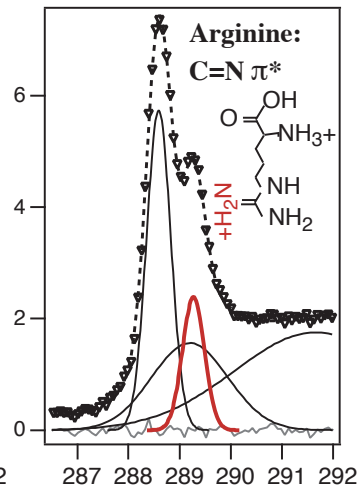
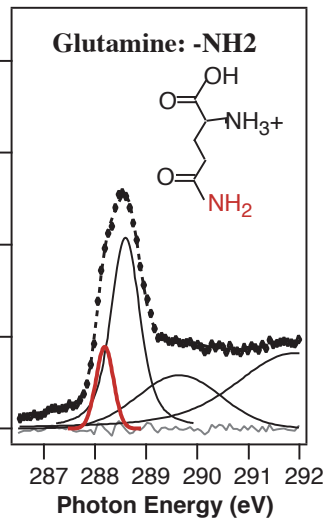
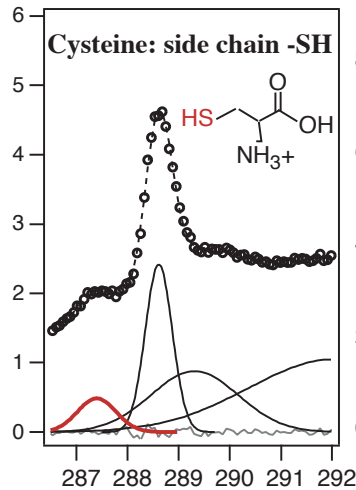
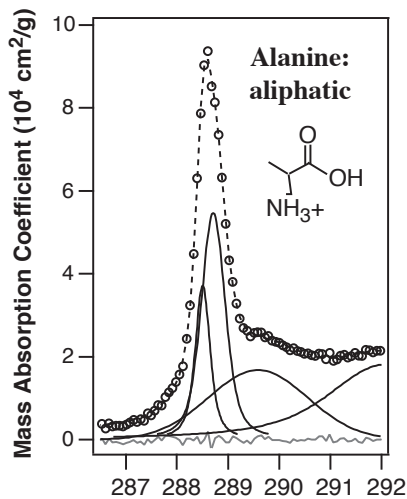
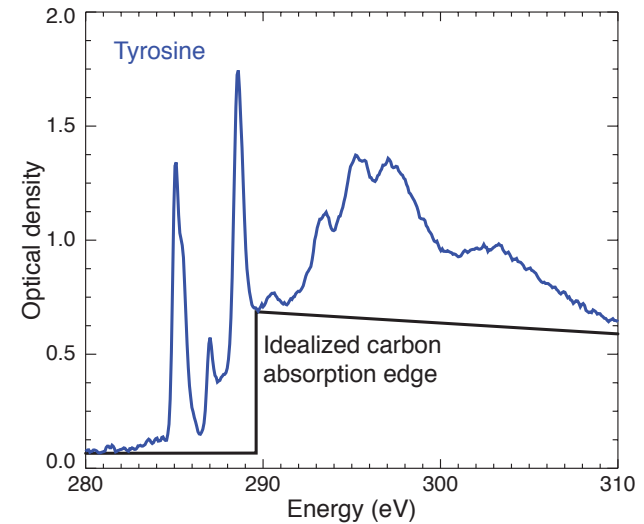
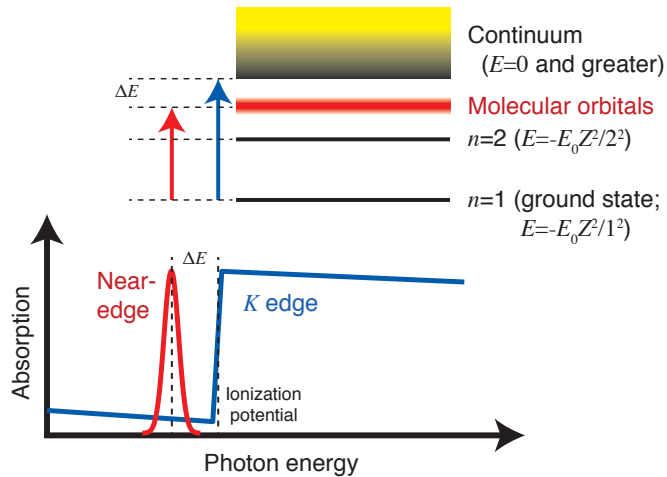

Amino acids example: K. Kaznacheyev *et al.*, *J. Phys. Chem. A* **106**, 3153 (2002)

Spectromicroscopy analysis

We measure the optical density $D = \mu t$ from $I = I_0 \exp[-\mu t]$, which gives us a matrix over $n=1..N$ energies and $p=1..P$ pixels of the **data**:

$$D_{N \times P} = \begin{bmatrix} D_{11} & \text{pixels} & D_{1P} \\ \text{spectra} & & \vdots \\ D_{N1} & \dots & D_{NP} \end{bmatrix}$$

We wish we could interpret this in terms of a set of $s=1..S$ components. We would then have a matrix of their **spectra**:

$$\mu_{N \times S} = \begin{bmatrix} \mu_{11} & \text{components} & \mu_{1S} \\ \text{spectra} & & \vdots \\ \mu_{N1} & \dots & \mu_{NS} \end{bmatrix}$$

We would also have a matrix of their weightings or **thicknesses**:

$$t_{S \times P} = \begin{bmatrix} t_{11} & \text{pixels} & t_{1P} \\ \text{components} & & \vdots \\ t_{S1} & \dots & t_{SP} \end{bmatrix}$$

What we have

What we wish we had

Doing the math

- We measure the **data** but want to interpret as **spectra** times **thicknesses**:

$$\begin{bmatrix} D_{11} & \text{pixels} & D_{1P} \\ \text{spectra} & & \vdots \\ D_{N1} & \dots & D_{NP} \end{bmatrix} = \begin{bmatrix} \mu_{11} & \text{components} & \mu_{1S} \\ \text{spectra} & & \vdots \\ \mu_{N1} & \dots & \mu_{NS} \end{bmatrix} \bullet \begin{bmatrix} t_{11} & \text{pixels} & t_{1P} \\ \text{components} & & \vdots \\ t_{S1} & \dots & t_{SP} \end{bmatrix}$$

or $D_{N \times P} = \mu_{N \times S} \cdot t_{S \times P}$

- If we know all S components and their **spectra** $\mu_{N \times S}$ we can obtain thickness maps:

$$t_{S \times P} = \mu_{S \times N}^{-1} \cdot D_{N \times P}$$

- Matrix $\mu_{S \times N}^{-1}$ of all spectra can be inverted using singular matrix decomposition (SVD). See e.g., Zhang *et al.*, *J. Struct. Biol.* **116**, 335 (1996); Koprinarov *et al.*, *J. Phys. Chem. B* **106**, 5358 (2002).

Optimization techniques in spectromicroscopy analysis

Global cost function F :

$$F(\mu, t) = \|D - \mu \cdot t\|_2^2 + \lambda_{\text{sparse}} \|t\|_1 + \lambda_{\text{sim}} \|\mu - \mu_{\text{cluster}}\|_2^2$$

- **Data matching**: reconstruction from spectra μ and images t should match optical density data D .
- **Sparseness**: maximize the separation of features in the images t . The L_1 norm provides a good measure of sparseness.
- **Similarity**: keep the spectra μ similar to those found in regions of the sample (μ_{cluster}).
- The regularization parameters λ are like a currency exchange rate to put all the costs on the same scale; increase λ until data matching error begins to grow significantly.
- Partial derivatives of each cost guide iterative solutions.
- Mak, M. Lerotic, H. Fleckenstein, S. Vogt, S. Wild, S. Leyffer, Y. Sheynkin, and C. Jacobsen, *Faraday Discussions* **171**, 357 (2014).

Finding a global minimum cost

- Search space over regularizers to find global cost minimum, while maximizing sparseness and cluster spectra similarity.
- R. Mak, PhD thesis, Northwestern University, 2014

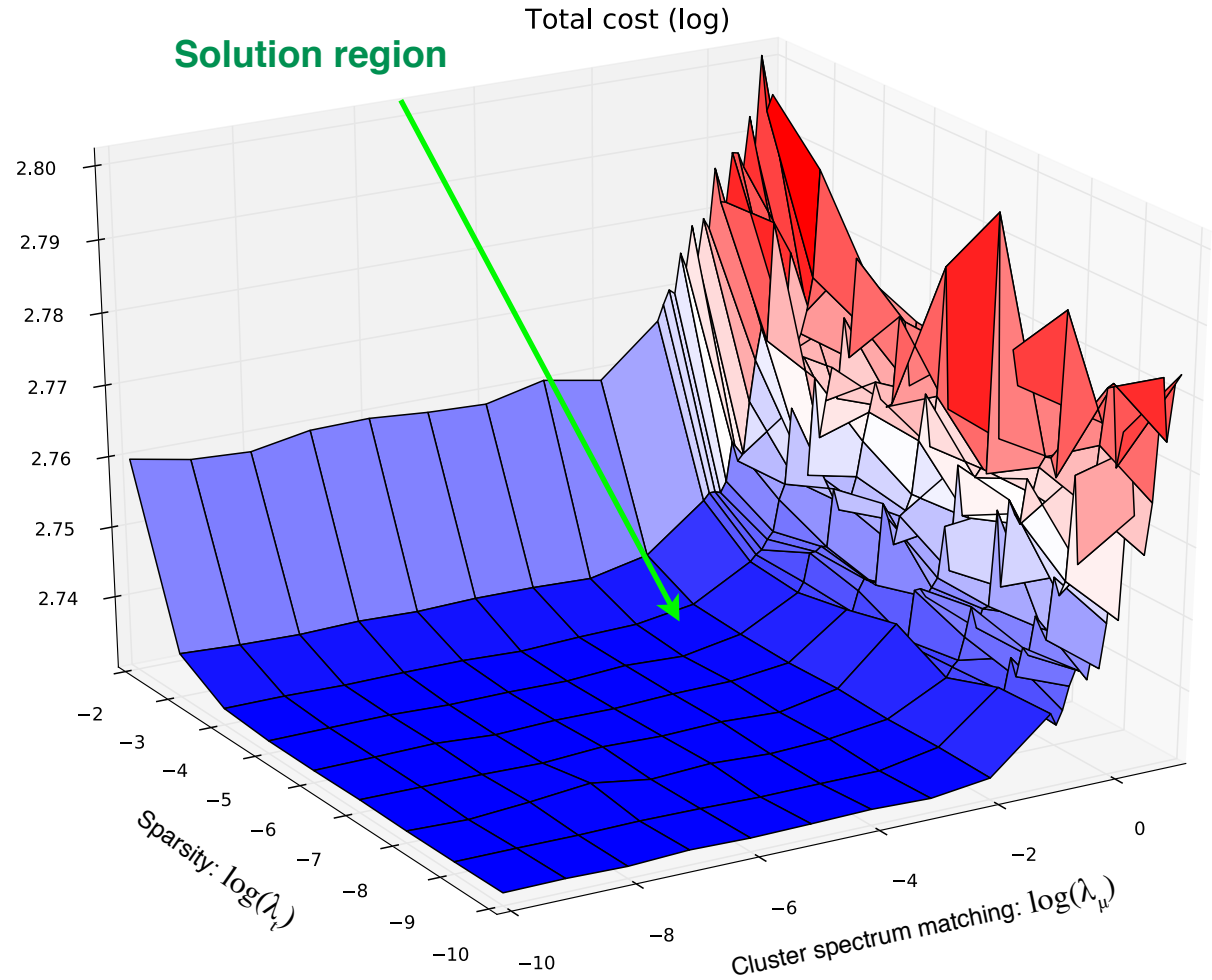

Optimized analysis

Faraday Discussions

Cite this: DOI: 10.1039/c4fd00023d



PAPER

View Article Online
View Journal

Non-negative matrix analysis for effective feature extraction in X-ray spectromicroscopy

Rachel Mak,^a Mirna Lerotic,^b Holger Fleckenstein,^c Stefan Vogt,^d Stefan M. Wild,^e Sven Leyffer,^e Yefim Sheynkin^f and Chris Jacobsen^{*dag}

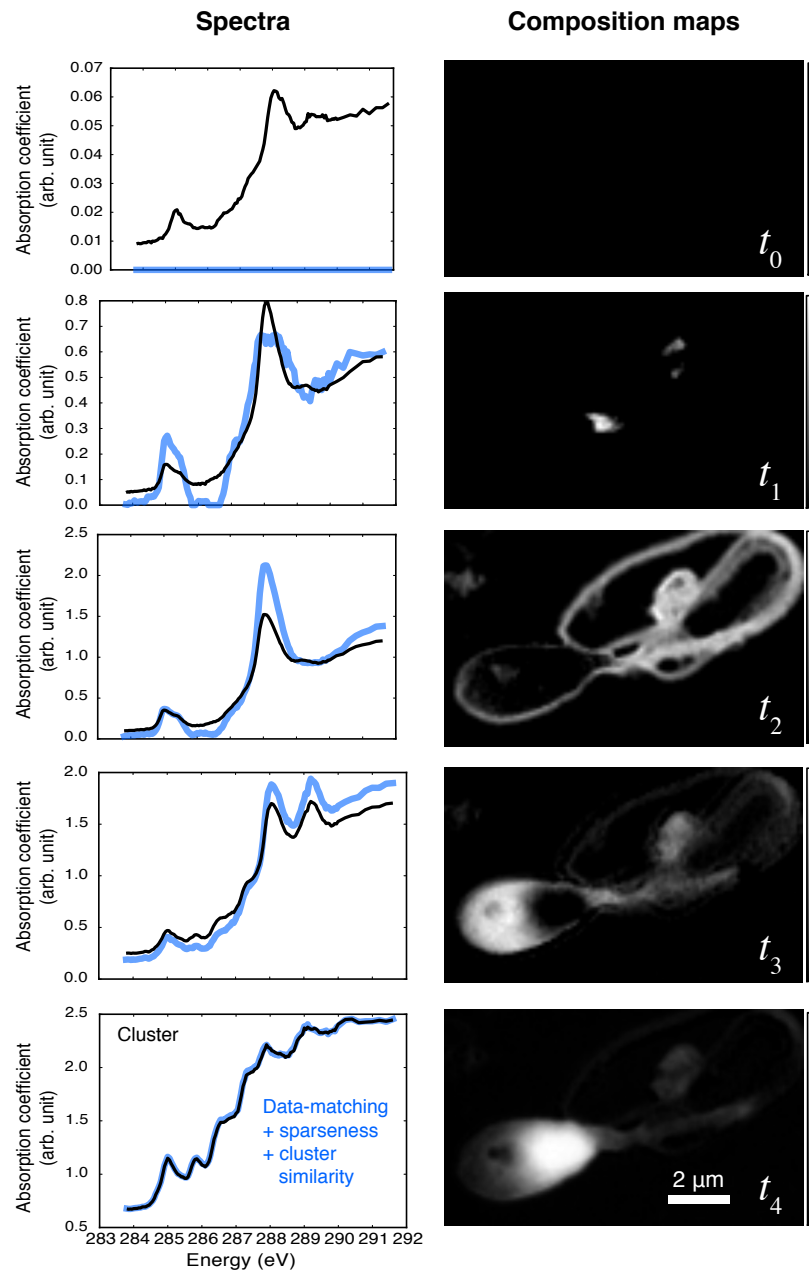
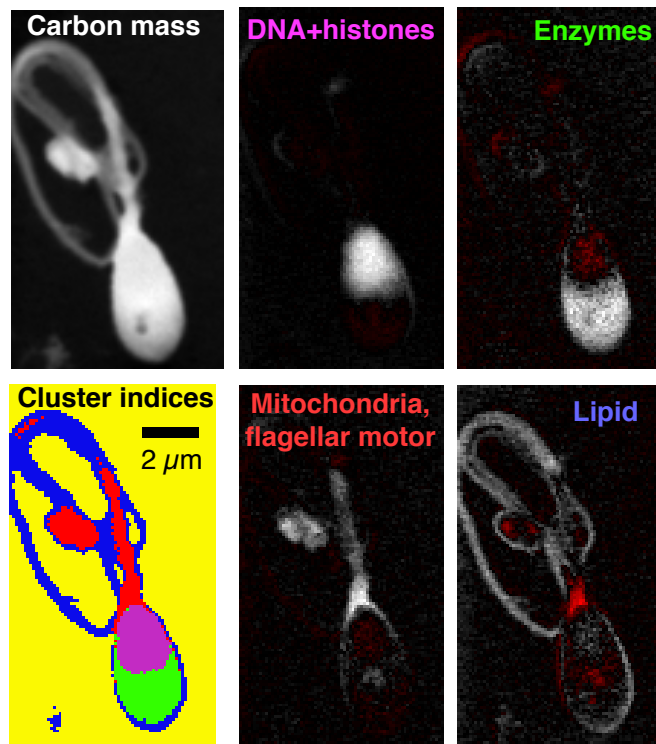

- We have N shoppers, and P items for purchase
- We want to find S customer types: $D_{N \times P} = C_{N \times S} \cdot R_{S \times P}$
- You, as customer n , match customer types given in $C_{N \times S}$
- Customer types S like to purchase items P as given by $R_{S \times P}$

Customers Who Bought This Item Also Bought



[Go Hang a Salami! I'm a Lasagna Hog!: and Other P...](#)
by Jon Agee

★★★★★ (7) \$6.96



[Sit on a Potato Pan, Otis!: More Palindromes](#) by Jon Agee

★★★★★ (2)

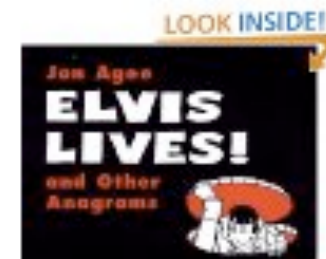

[Elvis Lives! and Other Anagrams \(Sunburst Book\)](#)
by Jon Agee

★★★★☆ (1) \$8.95

Netflix Awards \$1 Million Prize and Starts a New Contest

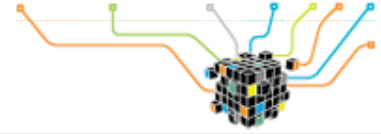

The New York Times

Monday, September 21, 2009

Bits

Business ■ Innovation ■ Technology ■ Society

“Netflix, the movie rental company, has decided its million-dollar-prize competition was such a good investment that it is planning another one. The company’s challenge, begun in October 2006, was both geeky and formidable: come up with a recommendation software that could do a better job accurately predicting the movies customers would like than Netflix’s in-house software, Cinematch. To qualify for the prize, entries had to be at least 10 percent better than Cinematch.”



Jason Kempin/Getty Images

A cartoon of the process

$$E_2 - E_1 = E_0 Z^2 \left(\frac{1}{1^2} - \frac{1}{2^2} \right) = \frac{3}{4} (13.6 \text{ eV}) Z^2$$

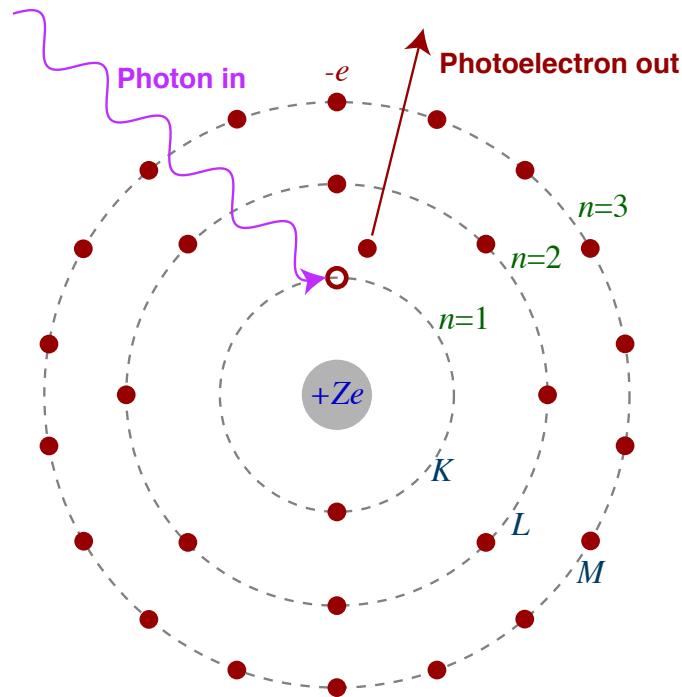

Absorb a photon;
create an inner-shell
vacancy. Must get rid
of the energy!

Either/or

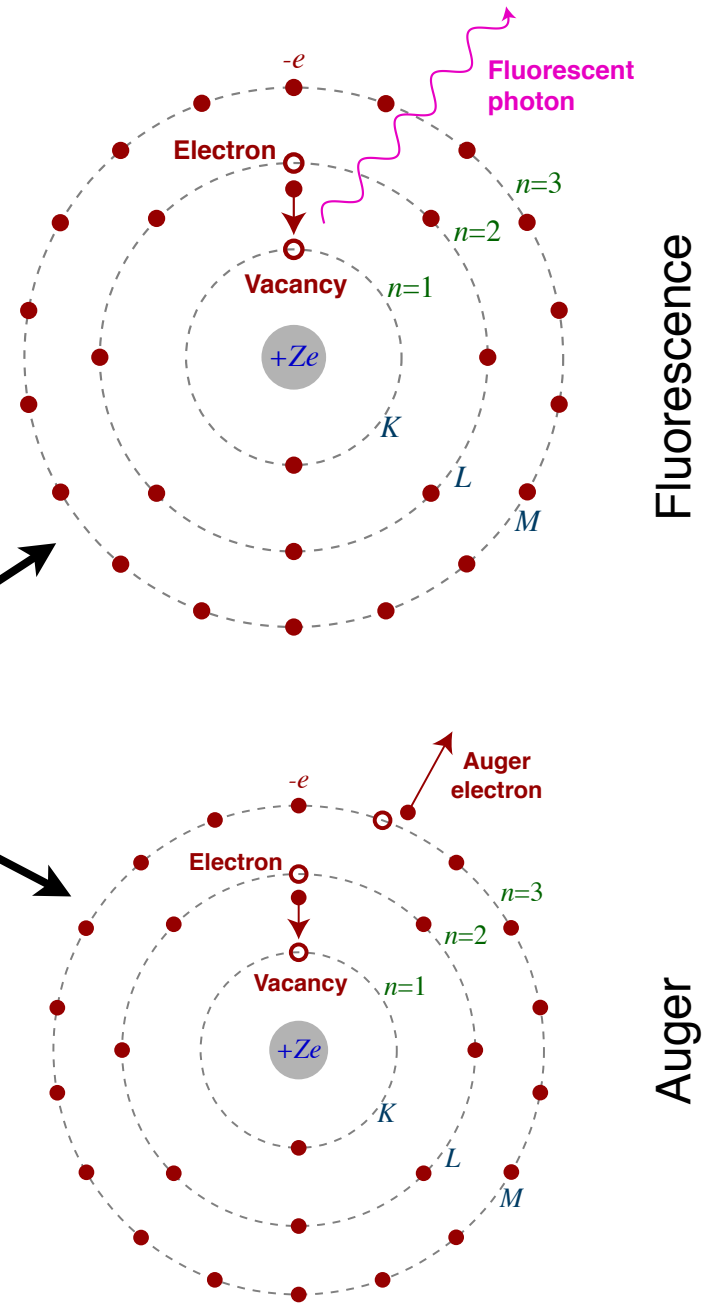

Electron binding and Stokes shifts

- One must first remove an electron, which takes more energy.
- Fluorescence then follows from an electron dropping down from a less strongly bound orbital.
- This difference between absorption edges and fluorescence lines is called the Stokes shift.

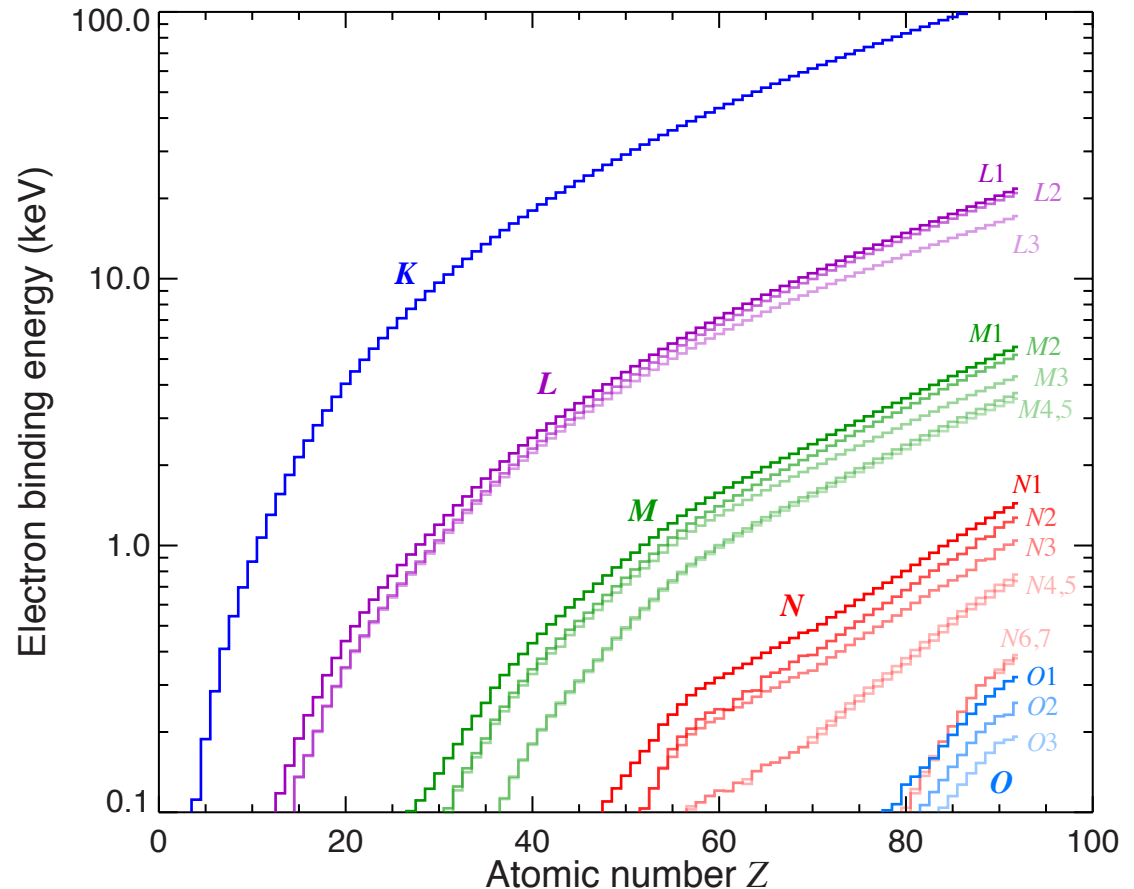

Tabulation: see *e.g.*, Elam, Ravel, and Sieber, *Radiation Physics and Chemistry* **63**, 121 (2002).

Python library xraylib: Schoonjans *et al.*, *Spectrochimica Acta B* **66**, 776 (2011)

Moseley's Law

- Henry Moseley (in Rutherford's lab in Manchester) found in 1913 that the photon energy of x-ray emission lines go as Z^2 .
- Predicted the existence of elements 43, 61, 72, and 75, and had a big influence on Bohr's theory.
- Killed by a sniper at Gallipoli, Turkey on Aug. 10, 1915.

$$n = 2 \rightarrow n = 1 : E = E_0 Z^2 \left(\frac{1}{1^2} - \frac{1}{2^2} \right) = \frac{3}{4} (13.6 \text{ eV}) Z^2$$

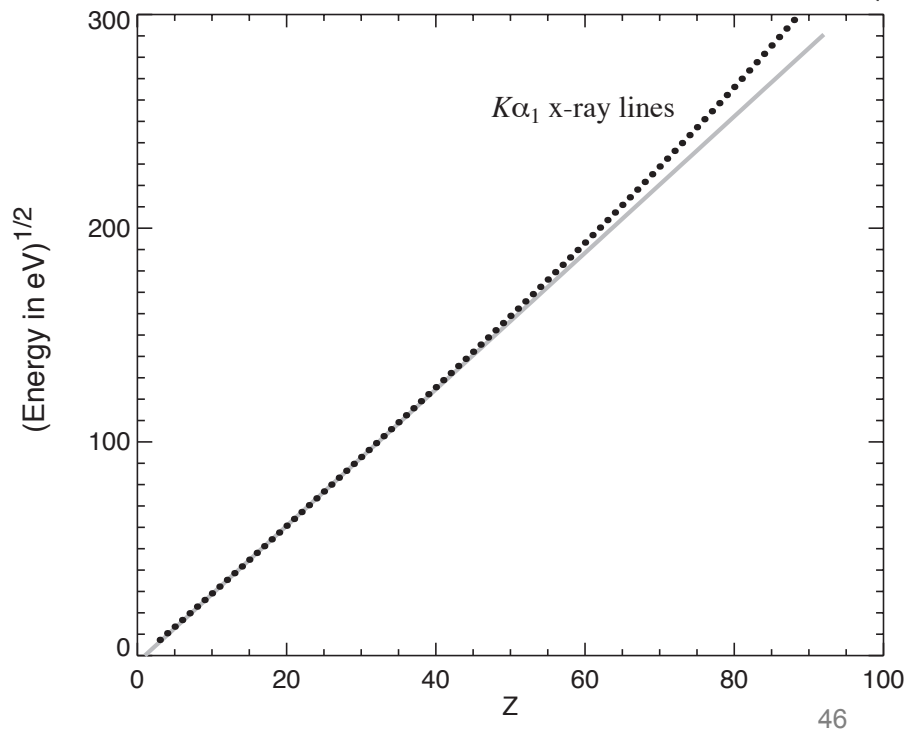

X-ray fluorescence energies

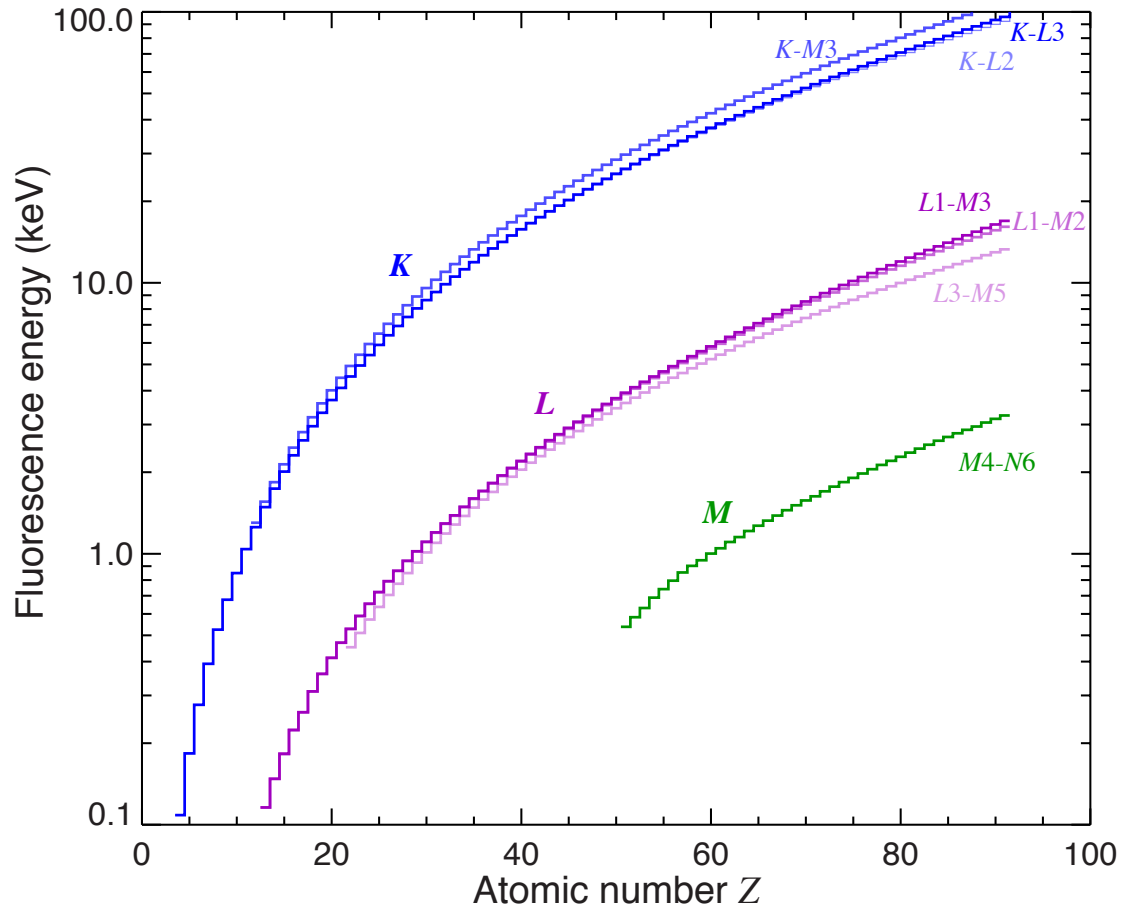

Tabulation: see *e.g.*, Elam, Ravel, and Sieber, *Radiation Physics and Chemistry* **63**, 121 (2002).

Python library xraylib: Schoonjans *et al.*, *Spectrochimica Acta B* **66**, 776 (2011)

Fluorescence yield ω

Fluorescence yield ω = fraction of time you get a fluorescent photon rather than an Auger electron

Tabulation: see *e.g.*, Elam, Ravel, and Sieber, *Radiation Physics and Chemistry* **63**, 121 (2002).

Python library xraylib: Schoonjans *et al.*, *Spectrochimica Acta B* **66**, 776 (2011)

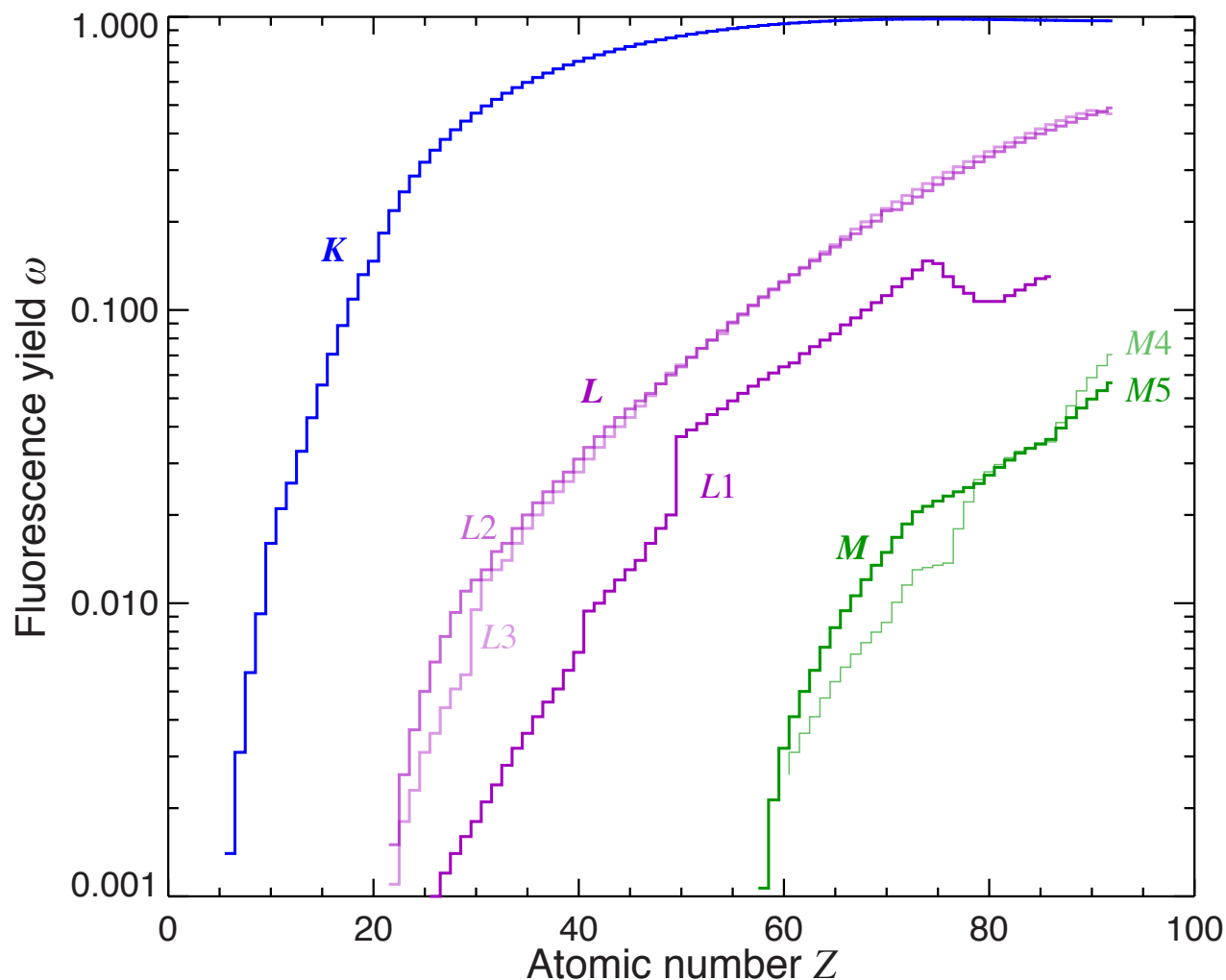

Fluorescence versus Auger

Fluorescence yield ω = fraction of time you get a fluorescent photon rather than an Auger electron

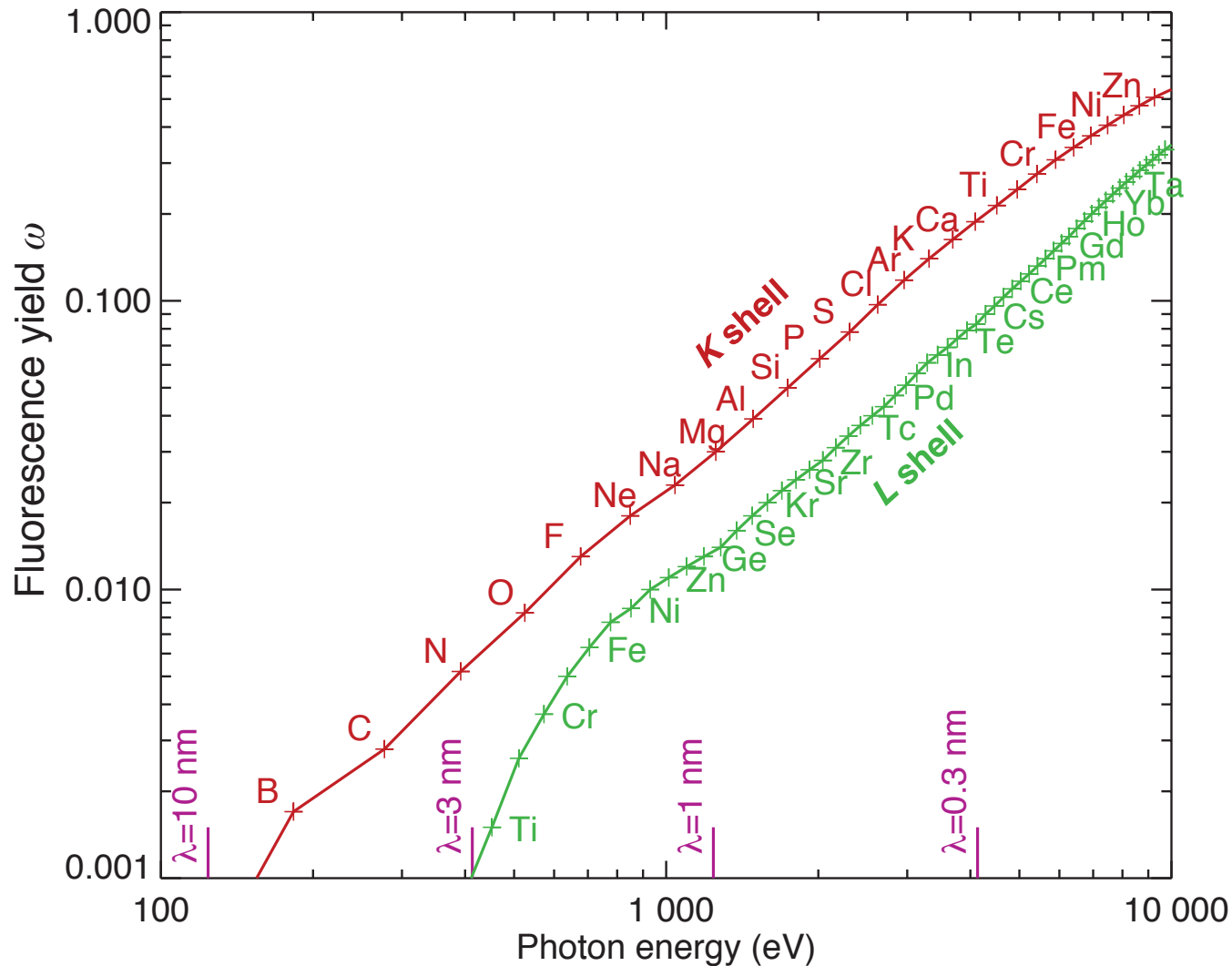

X-ray fluorescence microscopy

- Energy dispersive detectors: 3.65 eV per electron-hole pair separation in Si.
- 10 keV photon produces 2740 electrons. Fluctuations: $(2740)^{1/2}=52$, so uncertainty is $(52/2740)*10,000 \text{ eV}=190 \text{ eV}$.
- Detector at 90°: minimize elastic scattering.

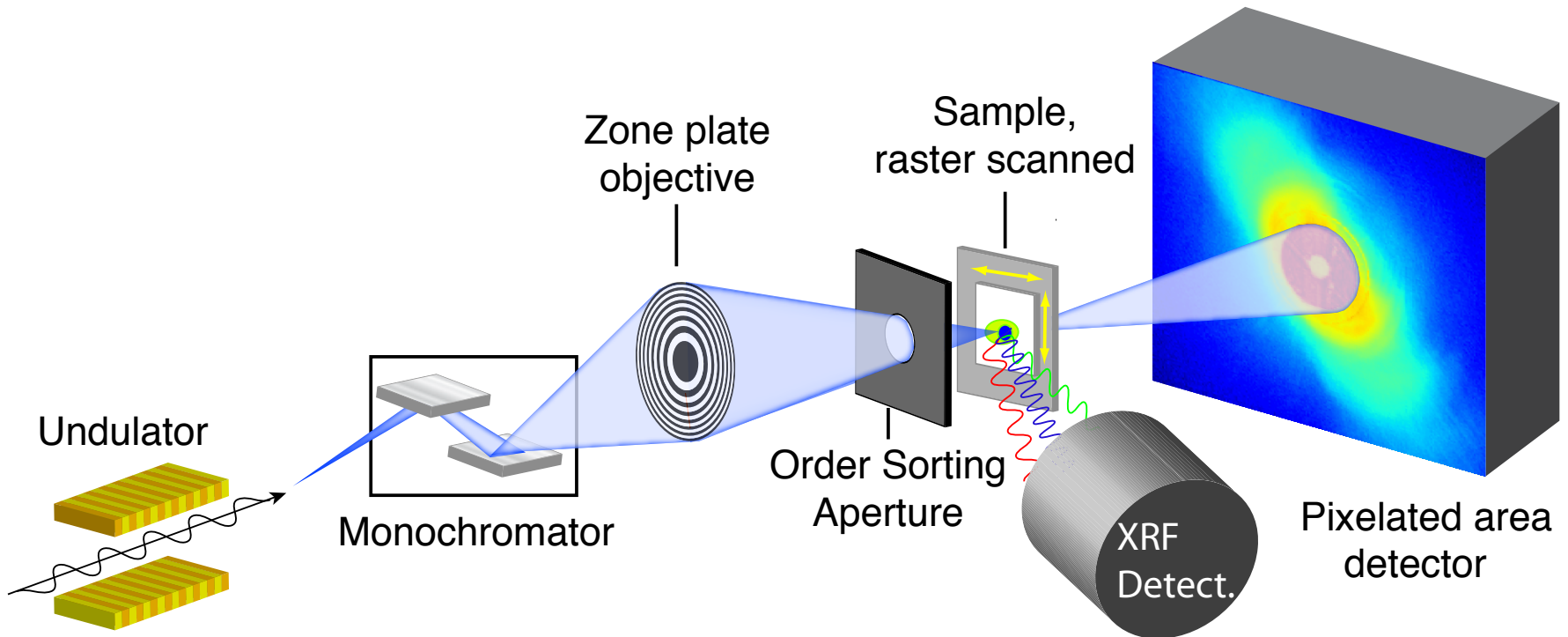

Fluorescence detector response to a 8 keV photon

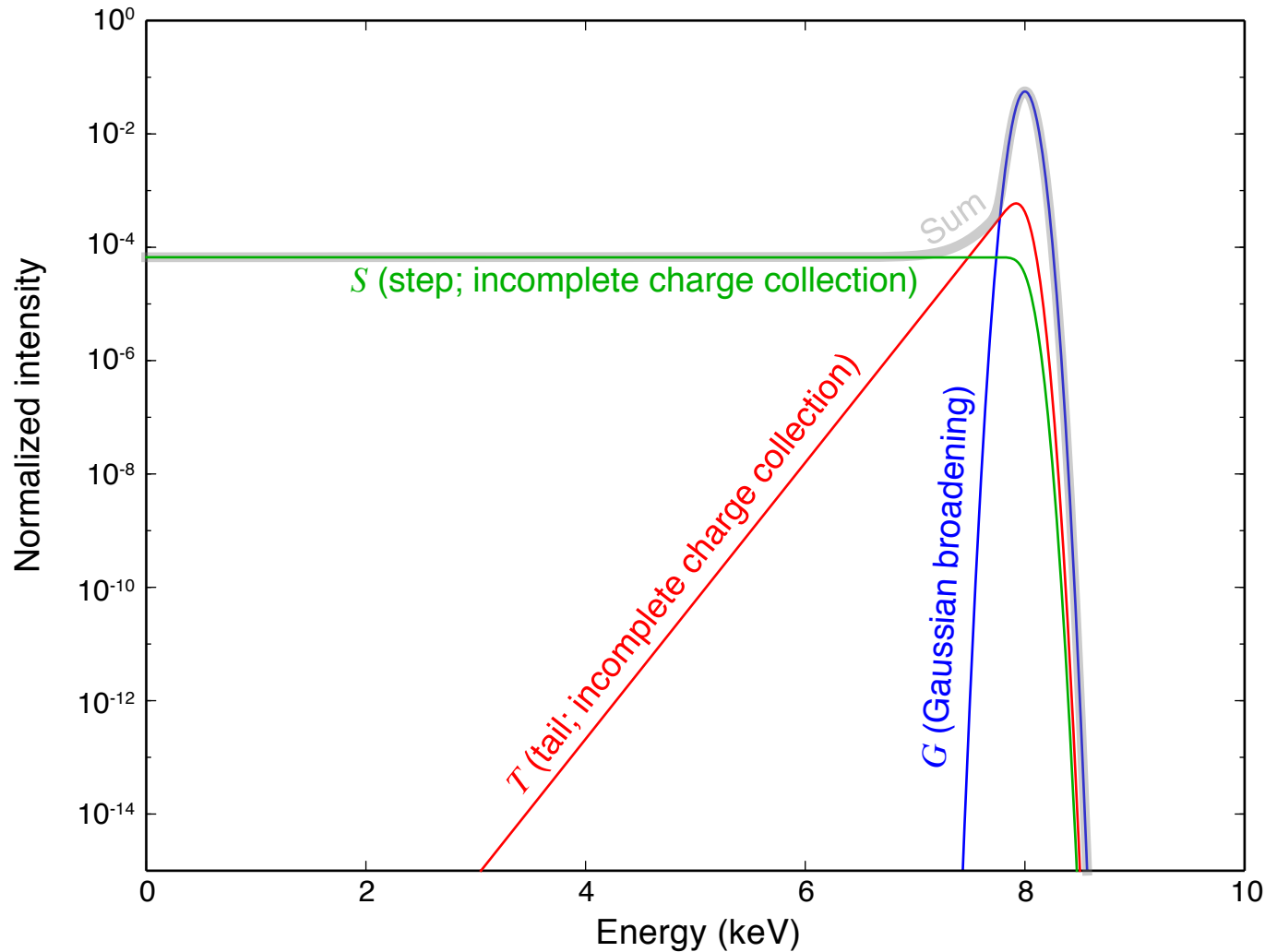

Van Grieken and Markowicz, *Handbook of X-ray Spectrometry* (CRC Press, 2001).
This plot from Sun, Gleber, Jacobsen, Kirz, and Vogt, *Ultramicroscopy* **152**, 44 (2015)

Example calculated x-ray spectrum

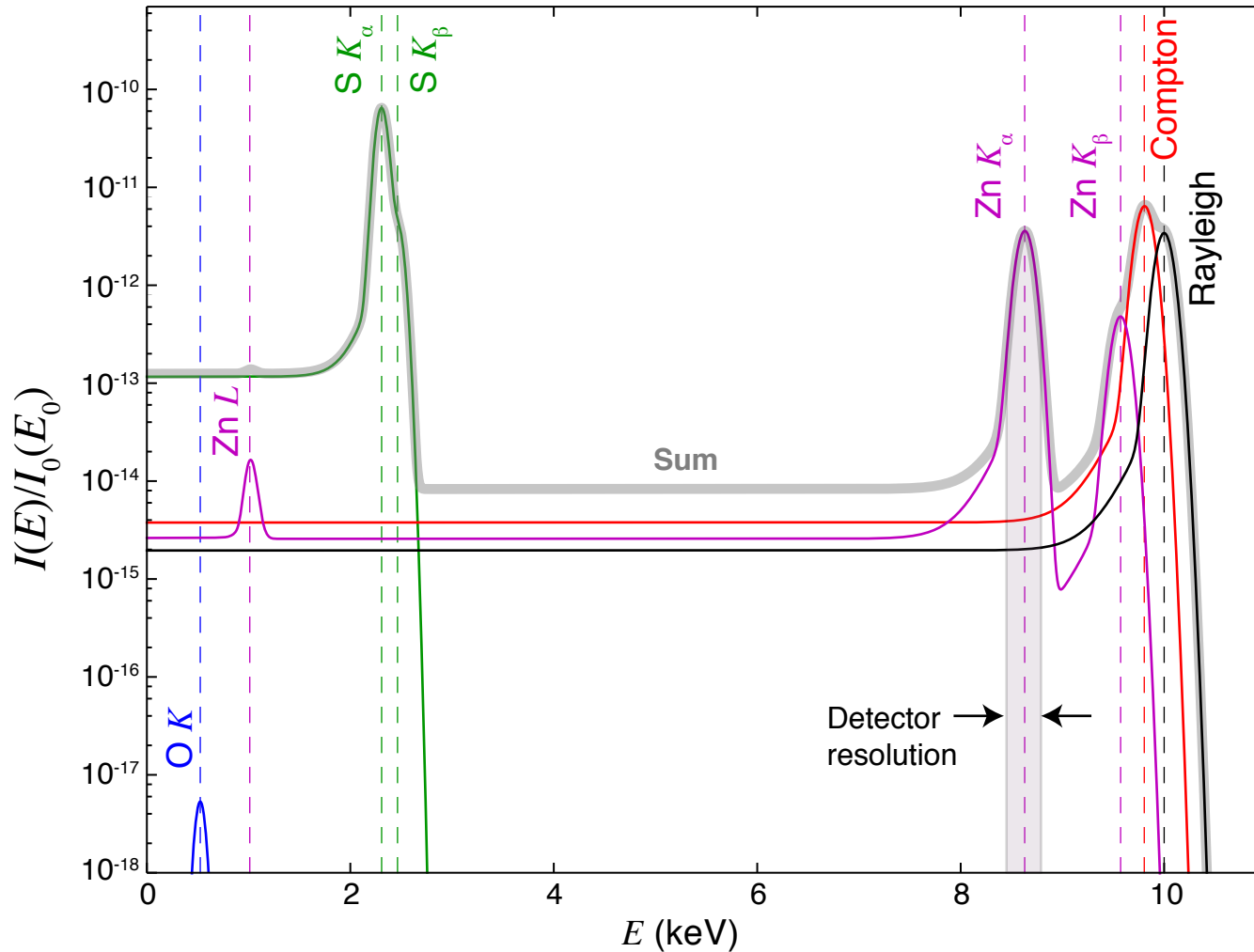

Sun, Gleber, Jacobsen, Kirz, and Vogt, *Ultramicroscopy* **152**, 44 (2015)

Example x-ray spectrum and fit

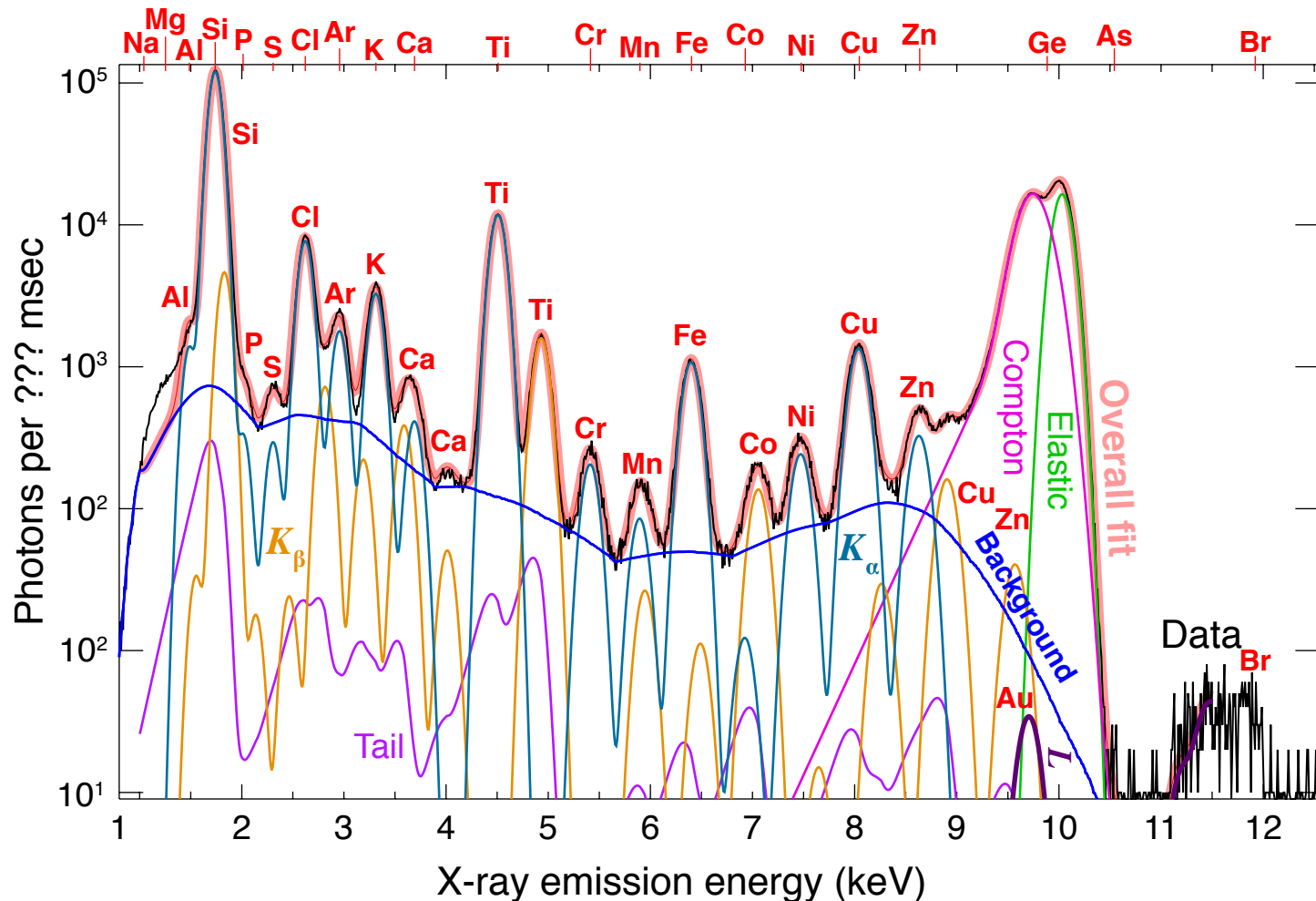

Spectrum: Olga Antipova, APS. Fit: S. Vogt, *J. Phys. IV France* **104**, 635 (2003). See also Ryan and Jamieson, *Nucl. Inst. Meth. B* **77**, 203 (1993); and Solé et al., *Spectrochimica Acta B* **62**, 63 (2007).

Quantitation

- While one should be able to calculate concentrations from first principles, there are many complicating factors:
 - Details of scattering and absorption (including Argon in air; 3.0 and 3.2 keV)
 - Details of detector response
 - Exact detector distance
- Therefore the usual practice is to use a spectral standard:
 - A “matrix” of a pure material (a polymer, or a glass) with scattering properties similar to the sample under study.
 - Into which are mixed in known quantities of elements to be measured, at concentrations similar to those expected in the specimen.
- Fit the spectrum to known peaks and detector response, and normalize the concentrations relative to the spectral standard.

Tomography at ~ 1 micrometer resolution

- Scintillator, visible light objective, visible light camera
- See Flannery *et al*, *Science* **237**, 1439 (1987). Also lectures by Marone.

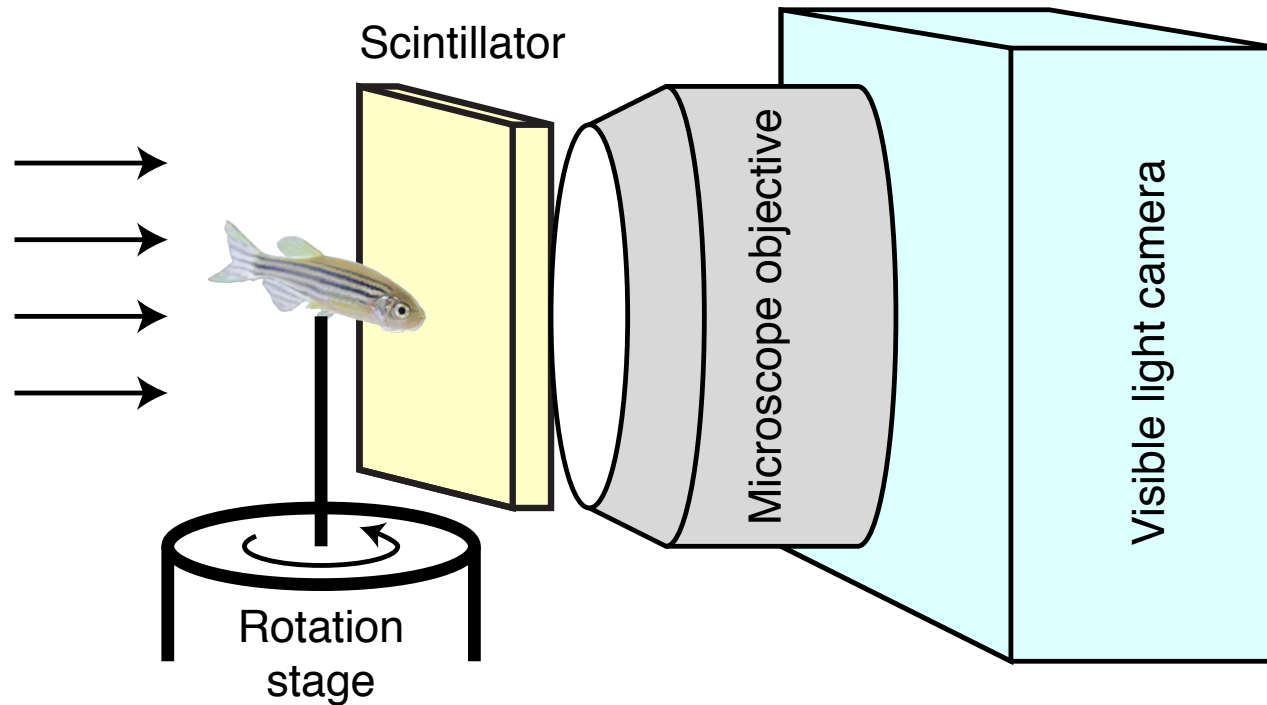

Tomography and sinograms

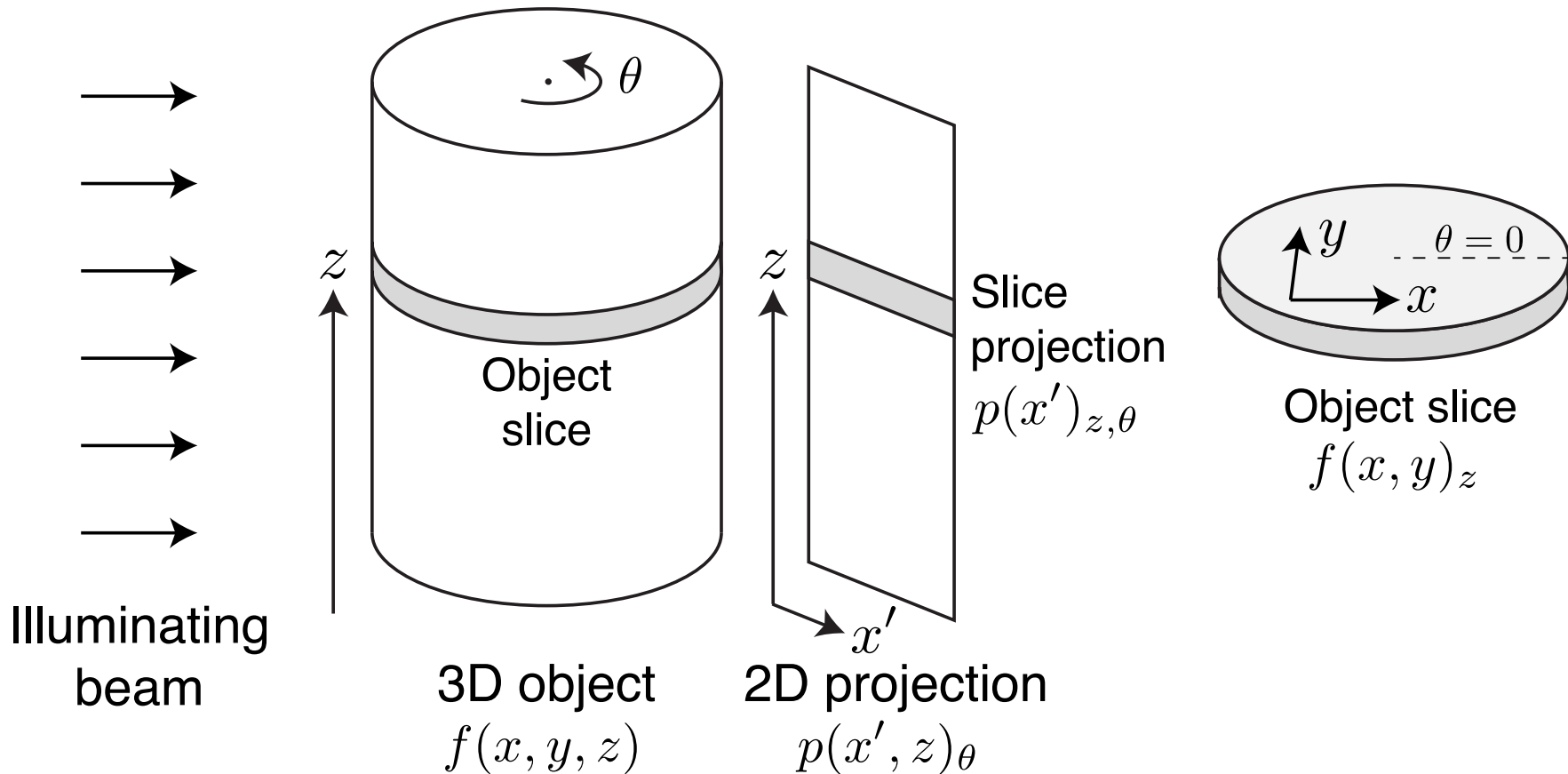

Tomography and sinograms

- Crowther criterion: fill information in to all voxels at the periphery in reciprocal space [Crowther, De Rosier, and Klug, *Proc. Royal Soc. A* **317**, 319 (1970)]

Oblique view of object slice $f(x, y)_z$

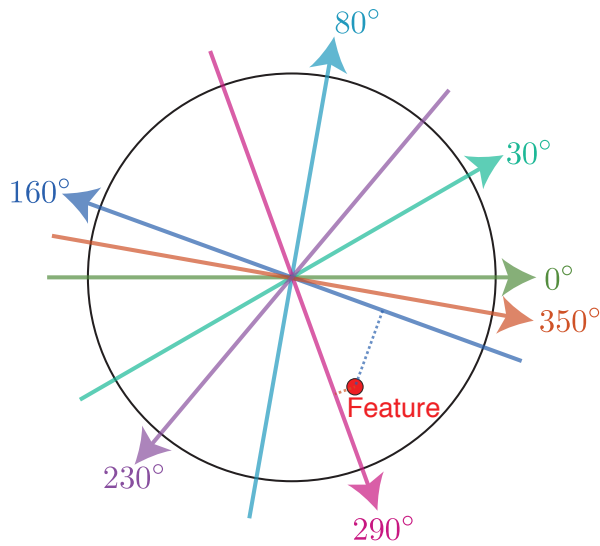
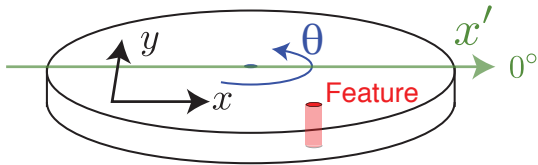

Top view of slice

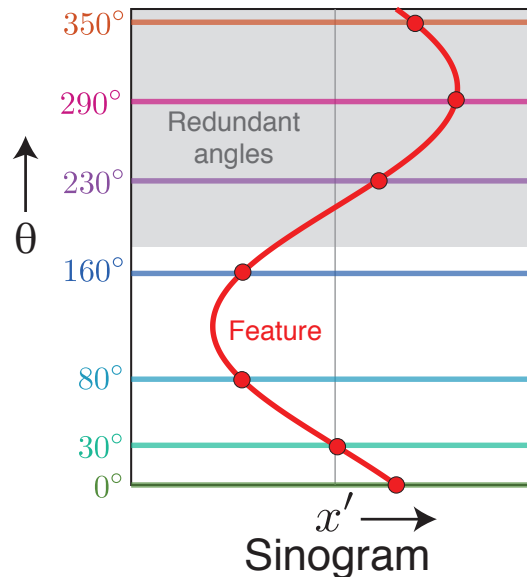

Sinogram

$$N_\theta = \pi N_x$$

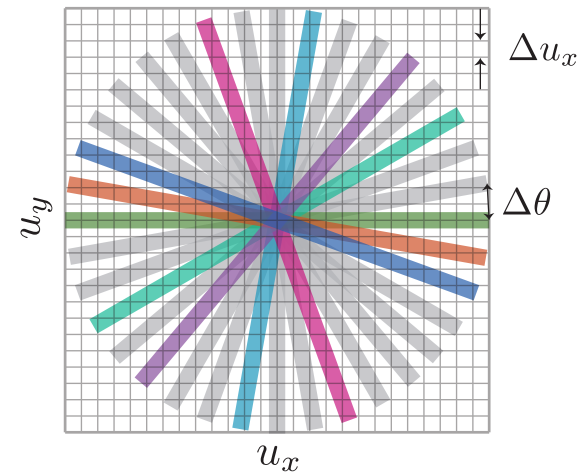

Fourier space $\mathcal{F}\{f(x, y)_z\}$

Limited tilt range artifacts

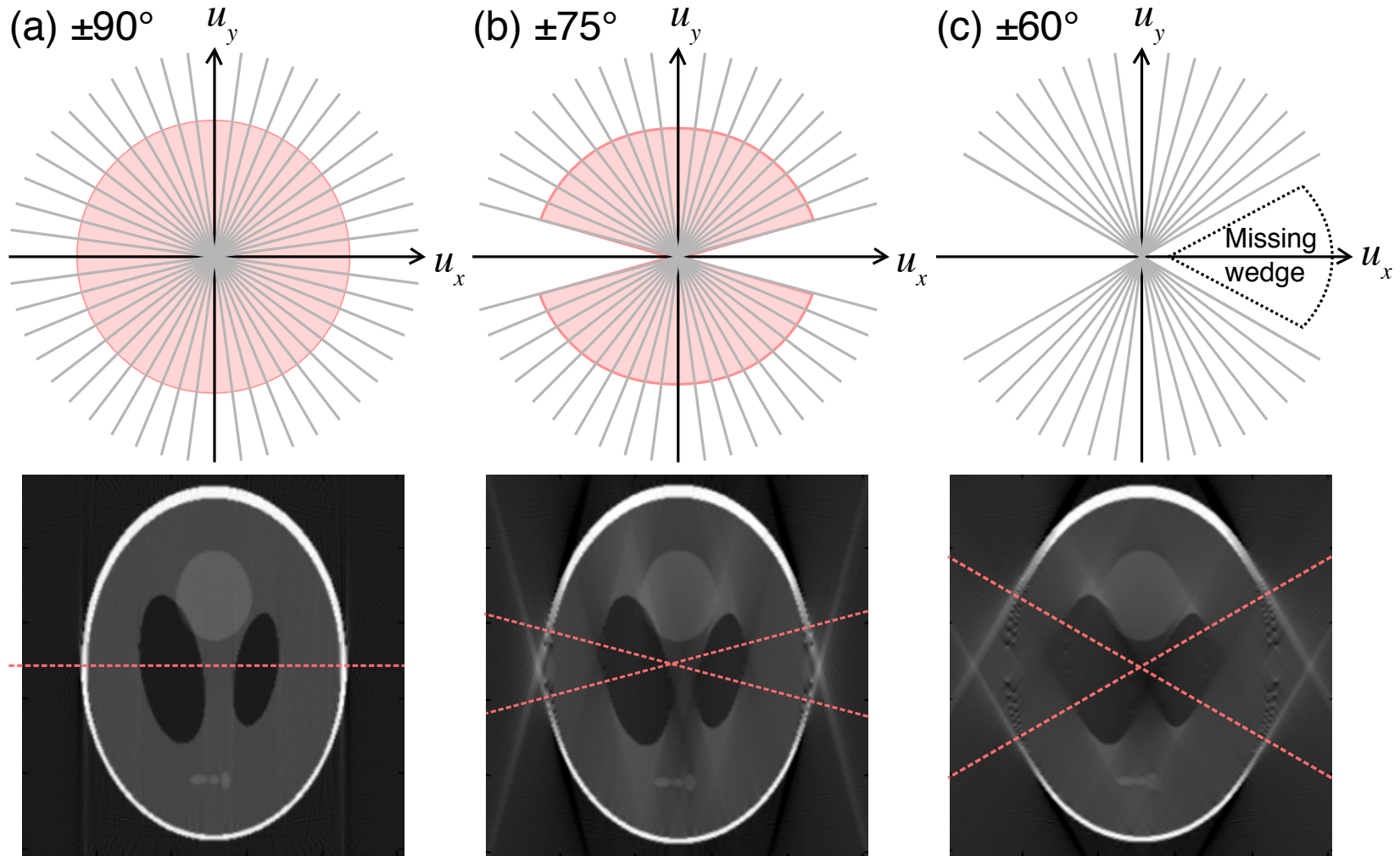

Tomography as a matrix equation

- A slice projection is given by a weighting matrix applied to the object slice

$$\mathbf{p}_{z,\theta} = \mathbf{w}(x', x)_\theta \cdot \mathbf{f}_z$$

- One can thus define a “cost” to be minimized (and additionally include other “costs” such as sparseness of the object, or noise models)

$$|\mathbf{p}_{z,\theta} - \mathbf{w}(x', x)_\theta \cdot \mathbf{f}_z|^2$$

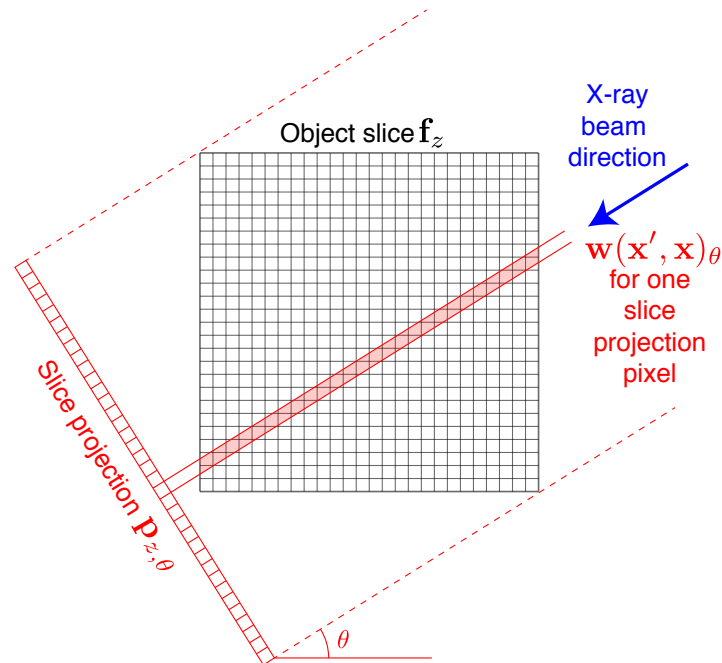

Tomography with limited projections

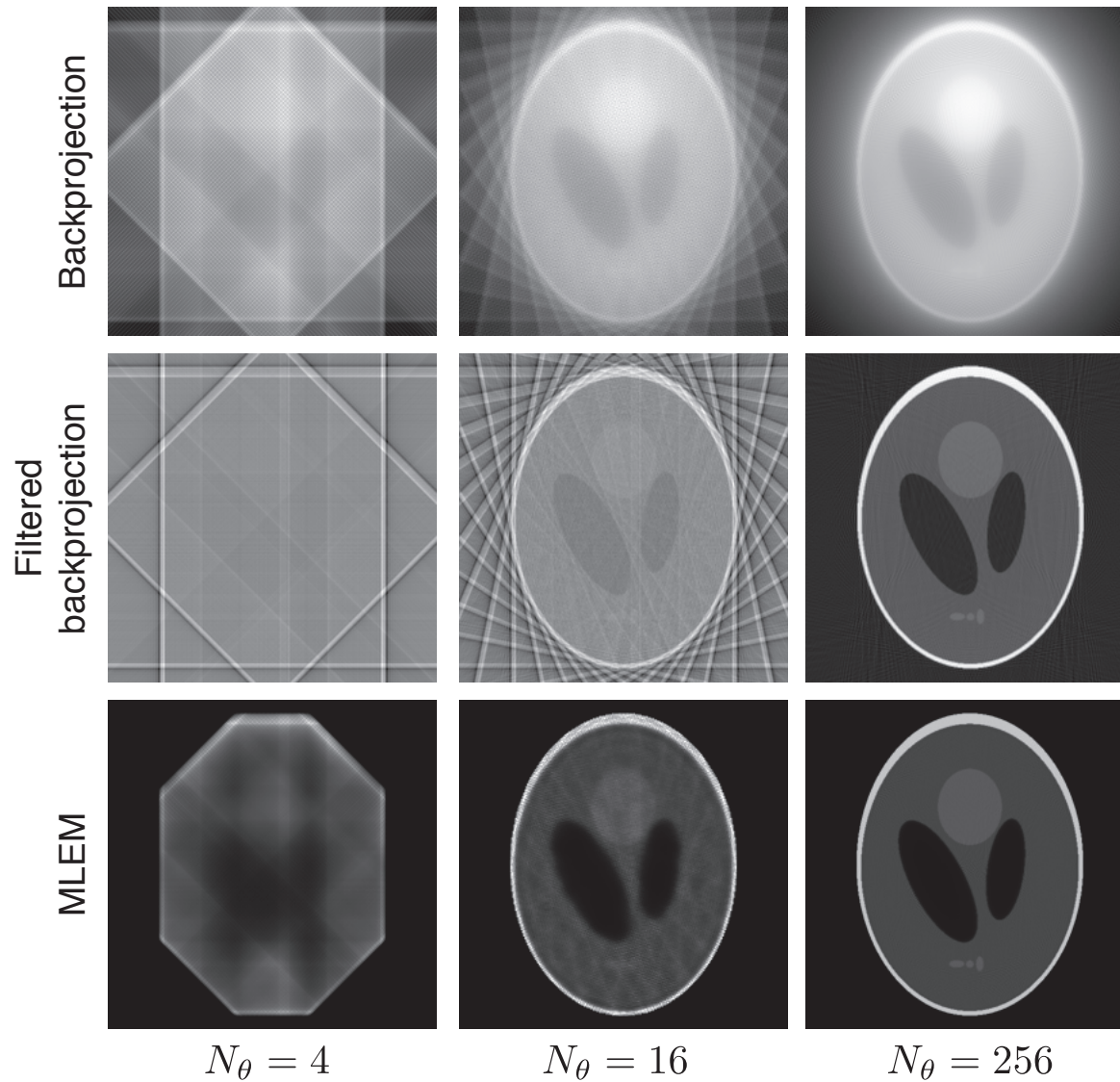

Tomography using projections from ptychography

- Holler *et al.*, *Scientific Reports* 4, 3857 (2014); C-SAXS at Swiss Light Source.
- 56 hours for 720 projections at 6.2 keV.
- Ta₂O₅ on nanoporous glass at 16 nm in 3D

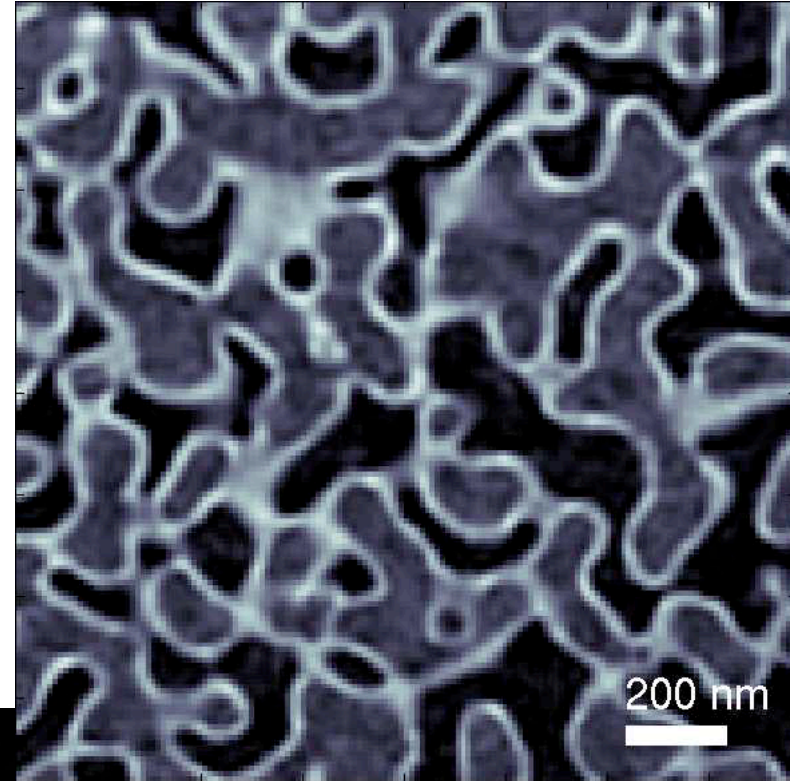

Aligning tomographic datasets

Iterative reprojection:

- Reconstruct from poor alignment.
- Align each projection to reconstruction
- Re-do reconstruction.
 - Electron microscopy and filtered backprojection: Dengler, *Ultramicroscopy* **30**, 337 (1989)
 - Incorporation into advanced tomographic reconstruction algorithms: Gürsoy, Hong, He, Hujsak, Yoo, Chen, Li, Ge, Miller, Chu, De Andrade, He, Cossairt, Katsaggelos, and Jacobsen, *Scientific Reports* **7**, 11818 (2017)

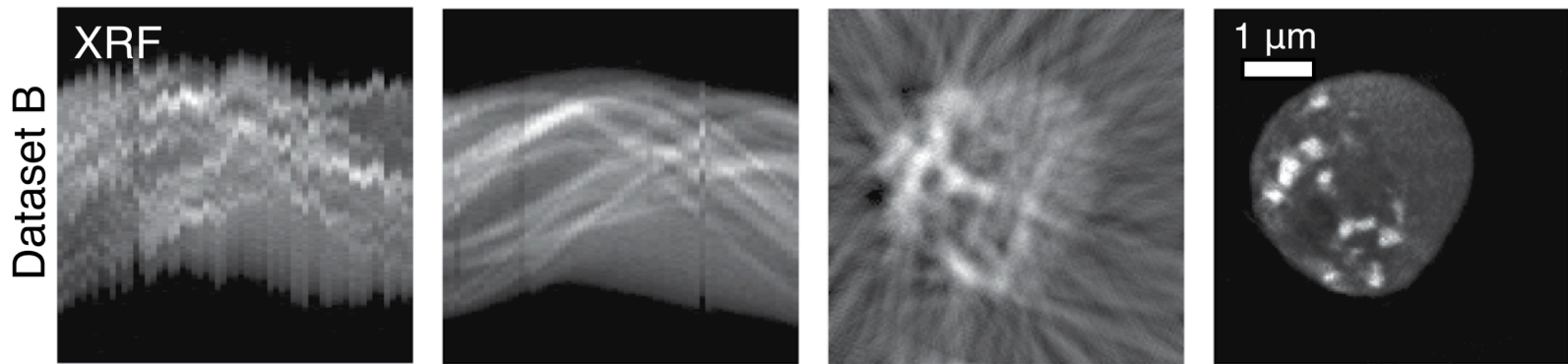

Poisson and Gaussian statistics

- Poisson distribution: if the average value over many, many tests is \bar{n} , what's the probability P of seeing n on one particular test?

$$P(n, \bar{n}) = \frac{\bar{n}^n}{n!} \exp(-\bar{n}).$$

- Gaussian distribution: same meaning for n , \bar{n} , and P , but valid only for large \bar{n} :

$$P(n, \bar{n}) = \frac{1}{\sqrt{2\pi\bar{n}}} \exp \left[-\frac{(n - \bar{n})^2}{2\bar{n}} \right]$$

“Bell curve”

Comparing Poisson (exact) and Gaussian

- The Gaussian approximation works well for even very small values of \bar{n}

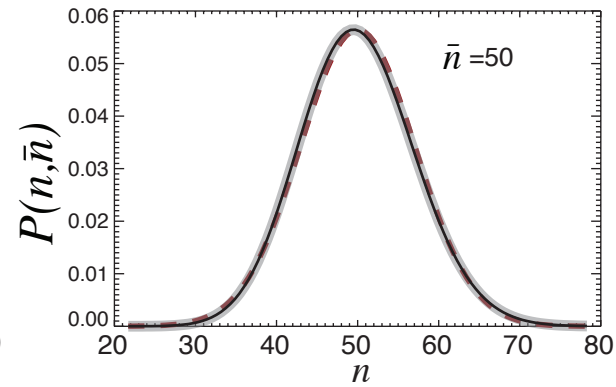
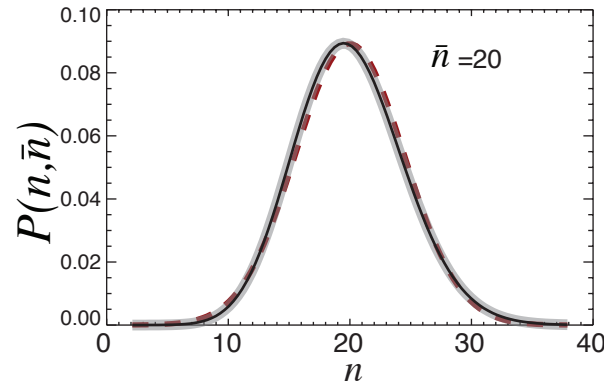
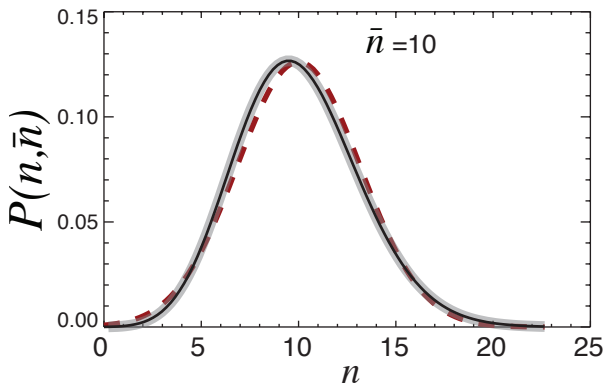
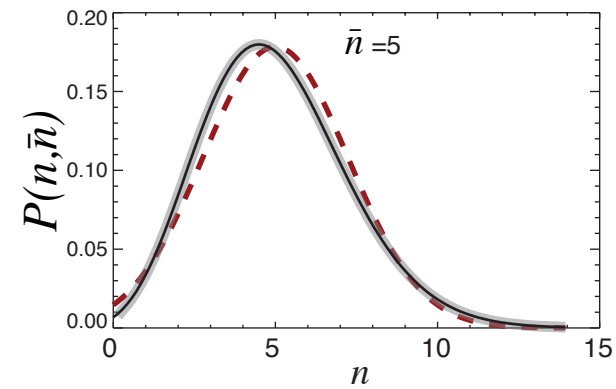
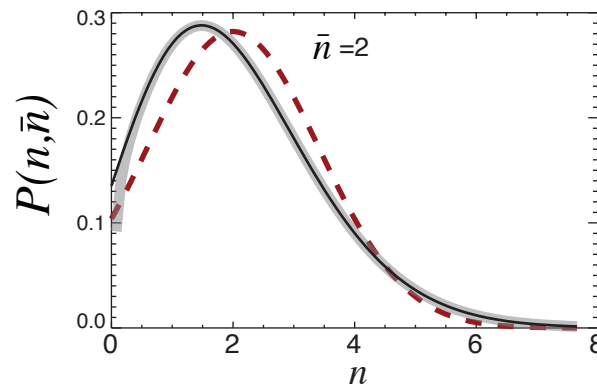
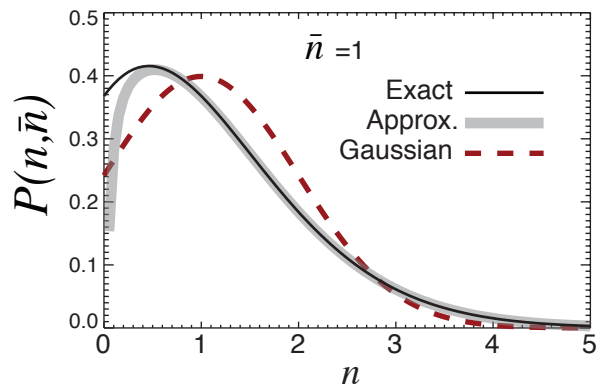

Signal to noise and required number of photons

- Simple statistics on \bar{n} incident photons:

$$\text{SNR} = \frac{\text{Signal}}{\text{Noise}} = \frac{\bar{n}|I_f - I_b|}{\sqrt{(\sqrt{\bar{n}}I_f)^2 + (\sqrt{\bar{n}}I_b)^2}} = \sqrt{\bar{n}} \frac{|I_f - I_b|}{\sqrt{I_f + I_b}} = \sqrt{\bar{n}}\Theta$$

where Θ =contrast parameter, I_f =intensity of feature, I_b =intensity of background. Also account for absorption in overlaying layers.

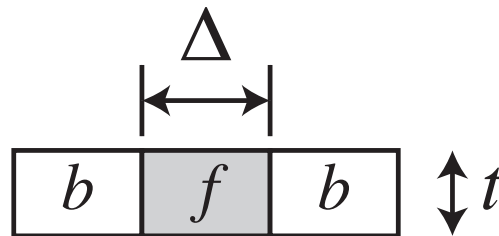

- Thus required number of incident photons \bar{n} is

$$\bar{n} = \frac{\text{SNR}^2}{\Theta^2}$$

- See e.g., Glaeser, *J. Ultrastruct. Res.* **36**, 466 (1971); Sayre *et al.*, *Ultramicroscopy* **2**, 337 (1977); Sayre *et al.*, *Science* **196**, 1339 (1977)

What about imaging in 3D?

- Rainer Hegerl and Walter Hoppe, *Zeitschrift für Naturforschung* **31**(a), 1717 (1976):

A three-dimensional reconstruction requires the same integral dose as a conventional two-dimensional micrograph provided that the level of significance and the resolution are identical. The necessary dose D for one of the K projections in a reconstruction series is, therefore, the integral dose divided by K .

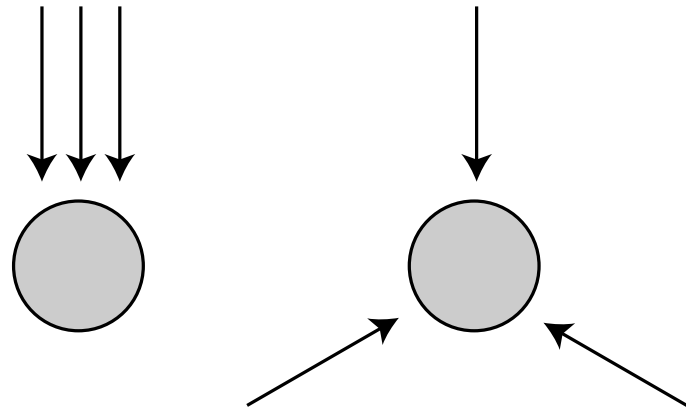

- Originally controversial; now embedded in practice of single particle electron microscopy, medical x-ray tomography.

Calculating dose

- SI units for ionizing radiation: 1 Gray=1 J/kg=100 rad
- Lambert-Beer law with inverse absorption length μ (=1.3 mm for protein at 8.98 keV):

$$I = I_0 e^{-\mu x} \quad \text{with} \quad \mu = 2 \frac{\rho N_A}{A} r_e \lambda f_2$$

- Energy per thickness with inverse absorption length μ :

$$\frac{dE}{dx} = h\nu \frac{dI}{dx} = h\nu \mu I_0 e^{-\mu \cdot 0} = I_0 h\nu \mu$$

- Energy per mass (note: I_0 is effectively \bar{n}):

$$\frac{dE}{dm} = \frac{dE}{dx} \frac{1}{\text{Area} \cdot \rho} = h\nu \mu I_0 \frac{1}{\text{Area} \cdot \rho} = h\nu \frac{I_0 \mu}{\text{Area} \cdot \rho}$$

Dose numbers

- G factor: number of bonds broken per 100 eV. $G \sim 5$ for many organic molecules (room temp.)
- Quick estimate to break 1 bond per atom:

$$\frac{(20 \text{ eV/atom}) \cdot (N_A \text{ atoms/mol}) \cdot (1.6 \times 10^{-19} \text{ J/eV})}{(12 \text{ g/mol}) \cdot (10^{-3} \text{ kg/g})} = 1.6 \times 10^8 \text{ Gray}$$

- Representative dose in crystallography:

$$\frac{10^{14} \text{ photons}}{(50 \mu\text{m})^2} \frac{(8979 \text{ eV/photon}) \cdot (1.6 \times 10^{-19} \text{ J/eV})}{(1300 \mu\text{m}) \cdot (1.35 \text{ g/cm}^3) \cdot (10^{-4} \text{ cm}/\mu\text{m})^3 \cdot (10^{-3} \text{ kg/g})} = 3.3 \times 10^7 \text{ Gray}$$

- “Henderson limit” [Henderson, *Q. Rev. Biophys.* **28**, 171 (1995)]: 2×10^7 Gray is when diffraction spots fade.
- X-ray microscopy: doses of 10^6 - 10^8 Gray are common, depending on resolution

Dose versus resolution for transmission x-ray imaging

- Calculation of radiation dose using best of phase, absorption contrast and 100% efficient imaging

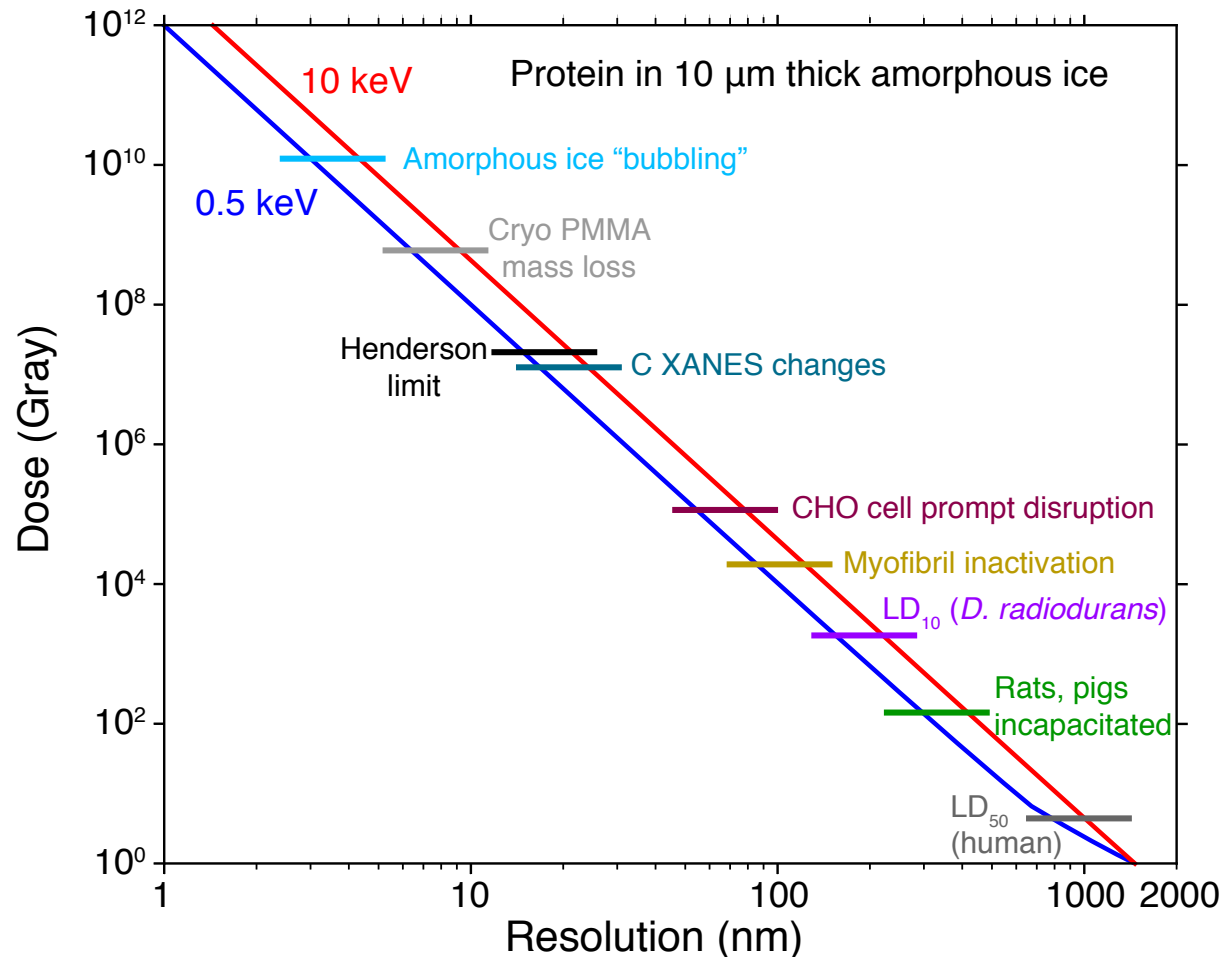

X-ray and electron microscopy are complementary

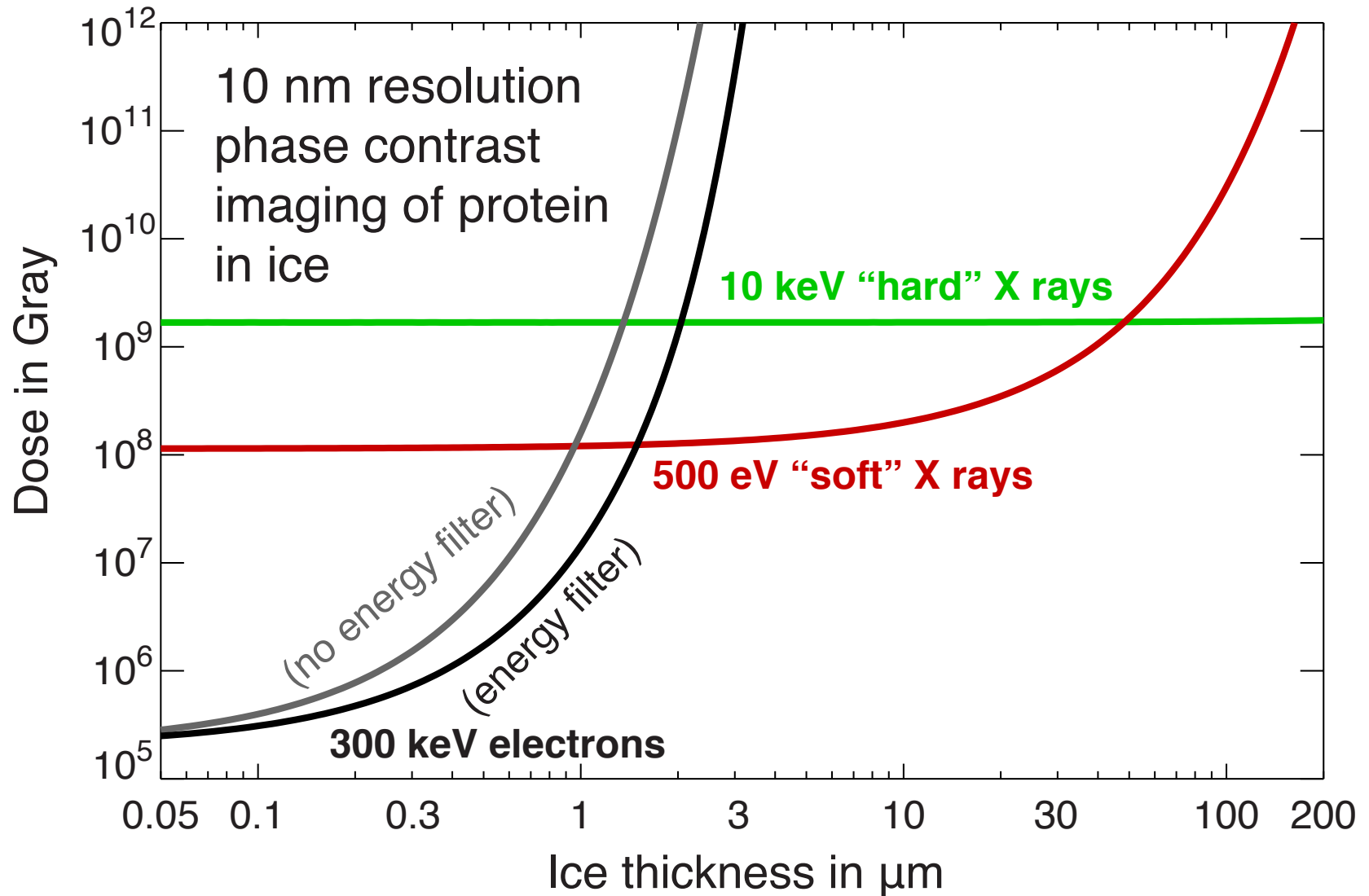

Ming Du and Chris Jacobsen, *Ultramicroscopy* **184**, 293-309 (2018). doi:10.1016/j.ultramic.2017.10.003

X-ray microscopy of initially living cells

- Radiation dose in high resolution x-ray, electron microscopy is $\sim 10^6$ - 10^8 Gray
- 5 Gray (really 5 Sievert) kills people!
- Chinese hamster ovarian (CHO) fibroblasts in culture medium with periodic reflow.
- “Red for dead” fluorescent dyes used to confirm viability over hours with no x-ray exposure.
- Imaged in a soft x-ray scanning transmission microscope (NSLS X1A)

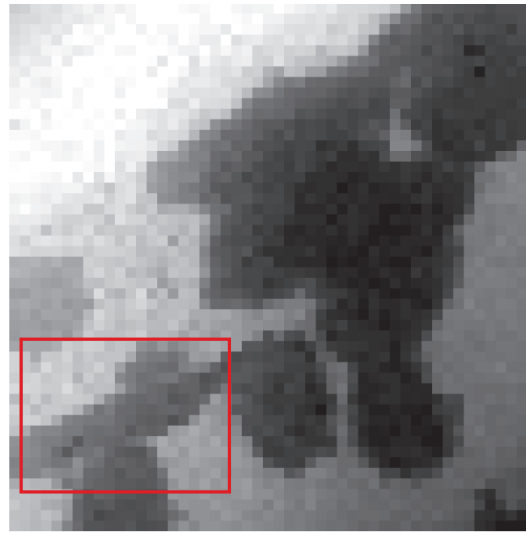

10 μm
 6.0×10^2 Gray, ET=2 minutes

Experiment by V. Oehler, J. Fu, S. Williams, and C. Jacobsen, Stony Brook using specimen holder developed by Jerry Pine and John Gilbert, CalTech. In Kirz, Jacobsen, and Howells, *Quarterly Reviews of Biophysics* **28**, 33 (1995).

1 Gray=1 Joule/kg absorbed
1 Sievert=1 Gray•RBE (relative biological effectiveness of radiation type)

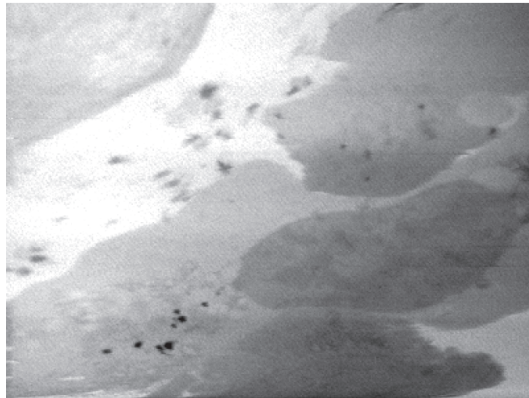

5 μm
 1.2×10^5 Gray, ET=9.5 min

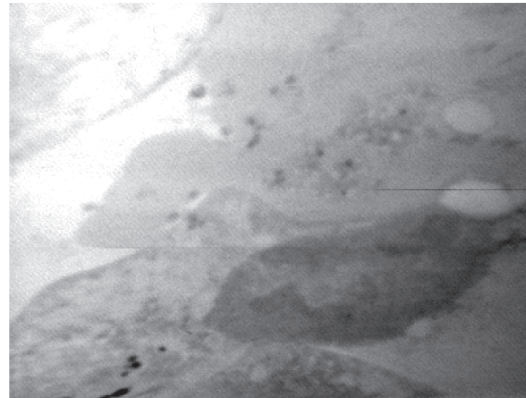

5 μm
 2.4×10^5 Gray, ET=17 min

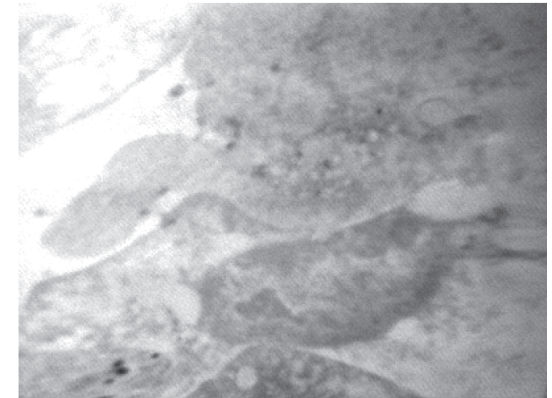

5 μm
 3.7×10^5 Gray, ET=24.5 min

Wet, fixed samples: one image is OK

- Chromosomes are among the most sensitive specimens.
- *V. faba* chromosomes fixed in 2% glutaraldehyde. S. Williams *et al.*, *J. Microscopy* **170**, 155 (1993)
- Repeated imaging of one chromosome shows mass loss, shrinkage

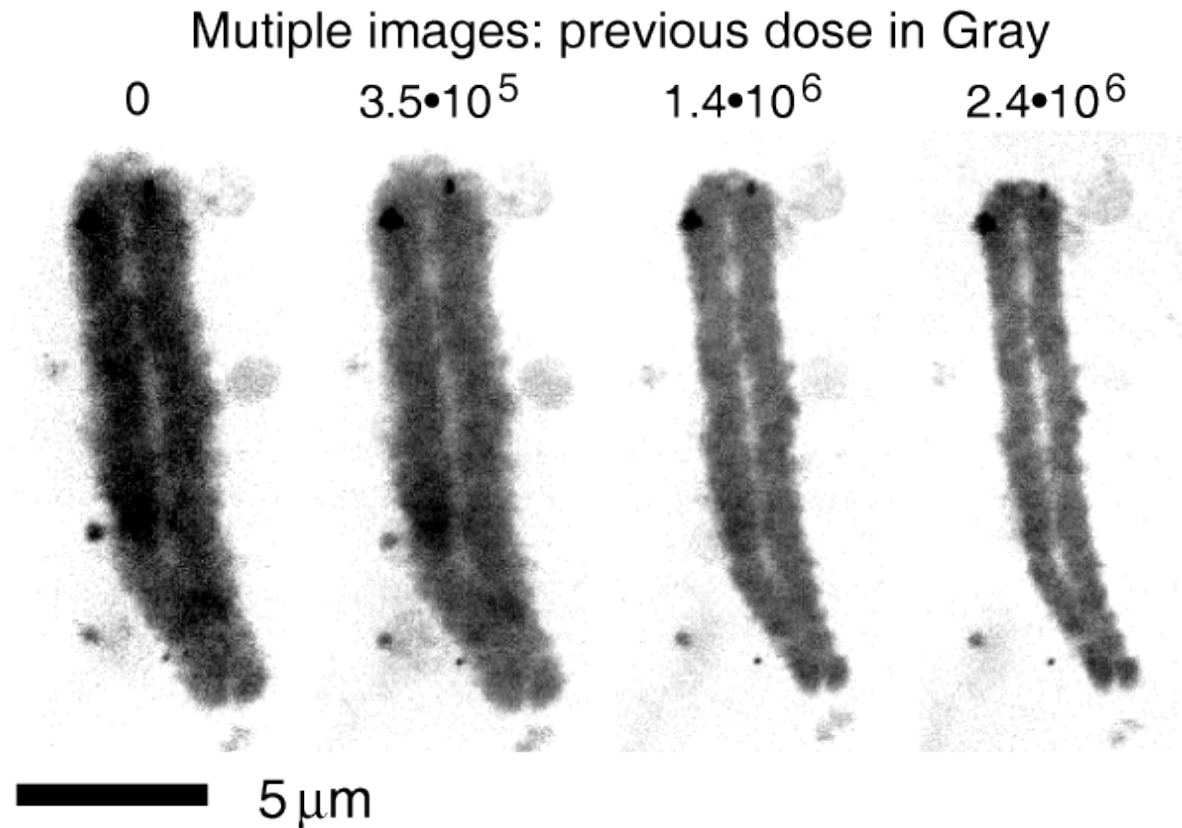

Cryo crystallography

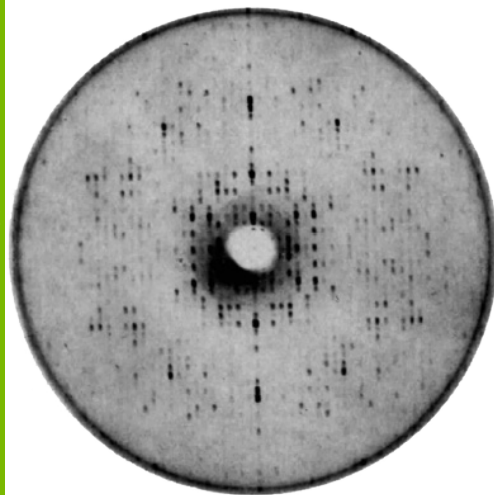

25°C

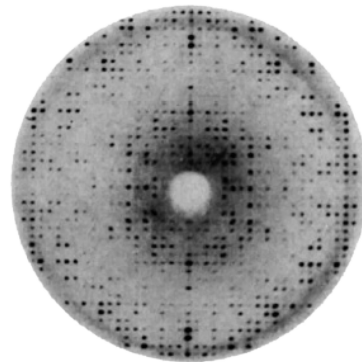

-75°C

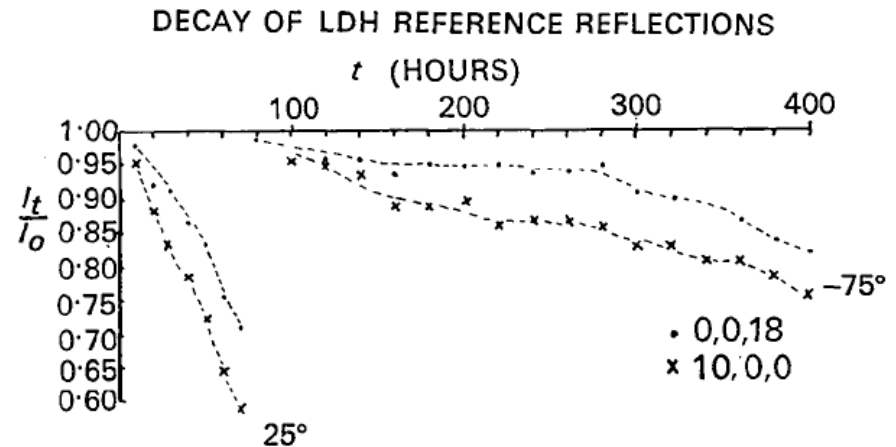

Fig. 5. The ratio I_t/I_0 for two reference reflections plotted as a function of exposure time for a typical native and frozen crystal. I_t represents the intensity at time t . Results for 0,0,18 and 10,0,0 are shown with dots and crosses respectively.

Acta Cryst. (1970). B26, 998

Crystallographic Studies on Lactate Dehydrogenase at -75°C

BY DAVID J. HAAS* AND MICHAEL G. ROSSMANN

Crystals of lactate dehydrogenase (LDH) were frozen by equilibration in a sucrose–ammonium sulfate solution, and then dipping into liquid nitrogen. The rate of radiation damage for frozen crystals was tenfold less than for crystals at room temperature. The physical properties of frozen crystals are discussed. Analysis of 3.5 Å data collected at -75°C for native LDH and two heavy atom derivatives showed that these derivatives retained their isomorphism in the frozen state.

See also Low, Chen, Berger, Singman, and Pletcher, *PNAS* 56, 1746 (1966)

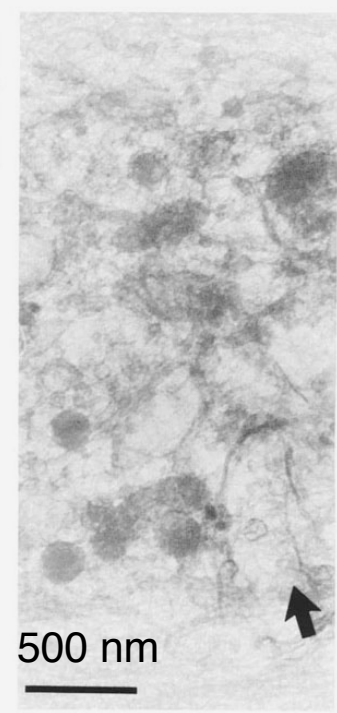
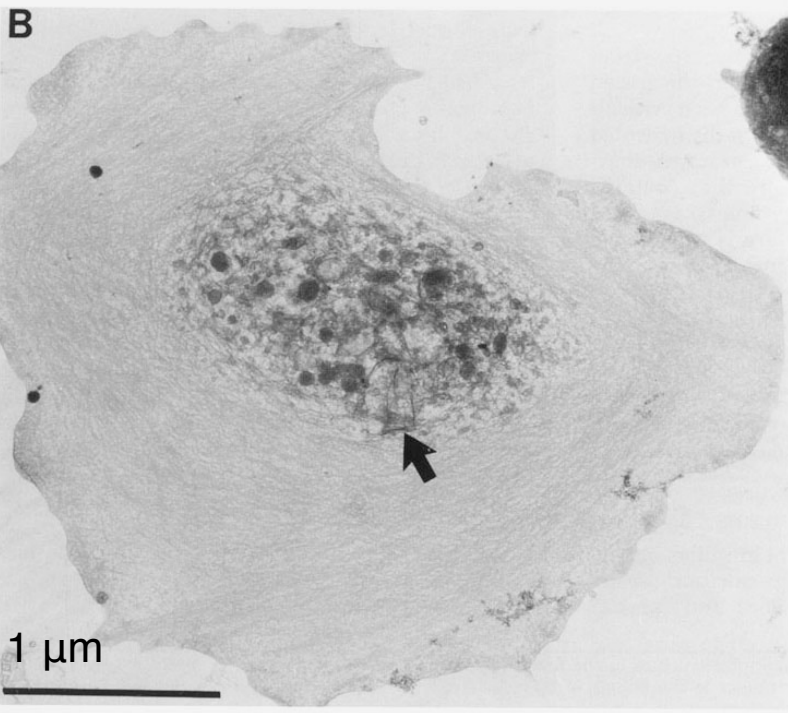
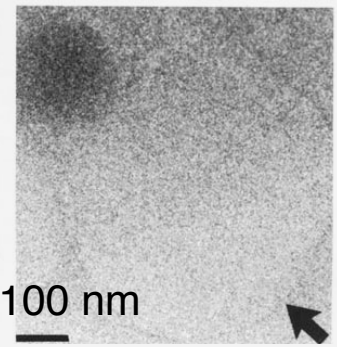
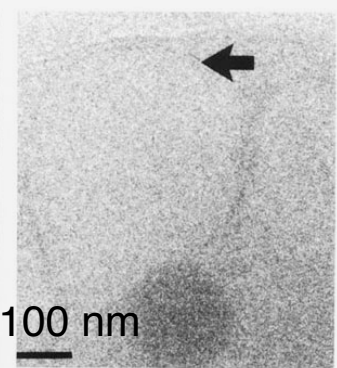
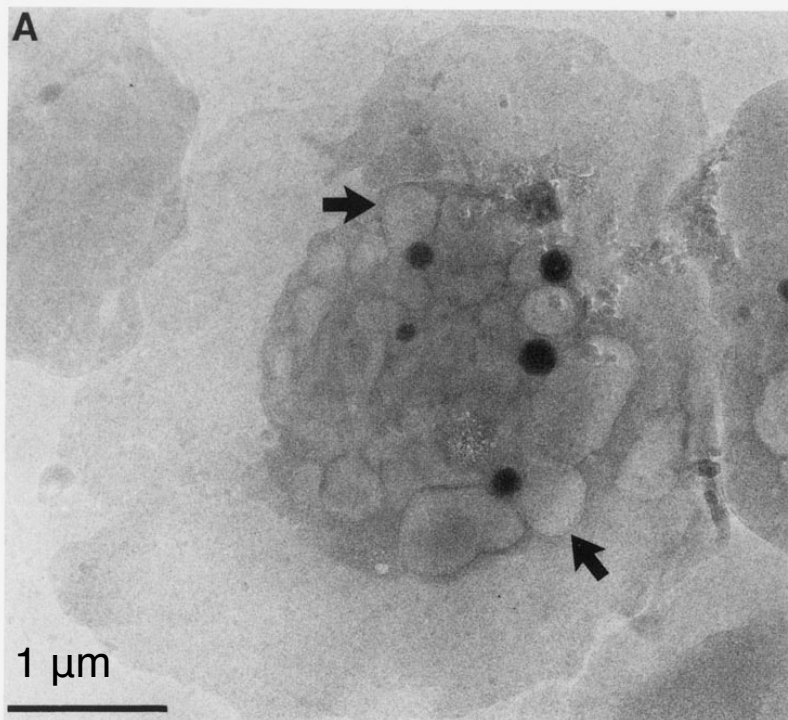

Frozen hydrated

- Human blood platelets
- 1 MeV transmission electron microscope (JEOL-1000)
- O'Toole, Wray, Kremer, and McIntosh, *J. Struct. Bio.* **110**, 55 (1993)

**2% glutaraldehyde fix
1% OsO₄ postfix
critical-point dry**

Cryo preservation keeps chemistry intact

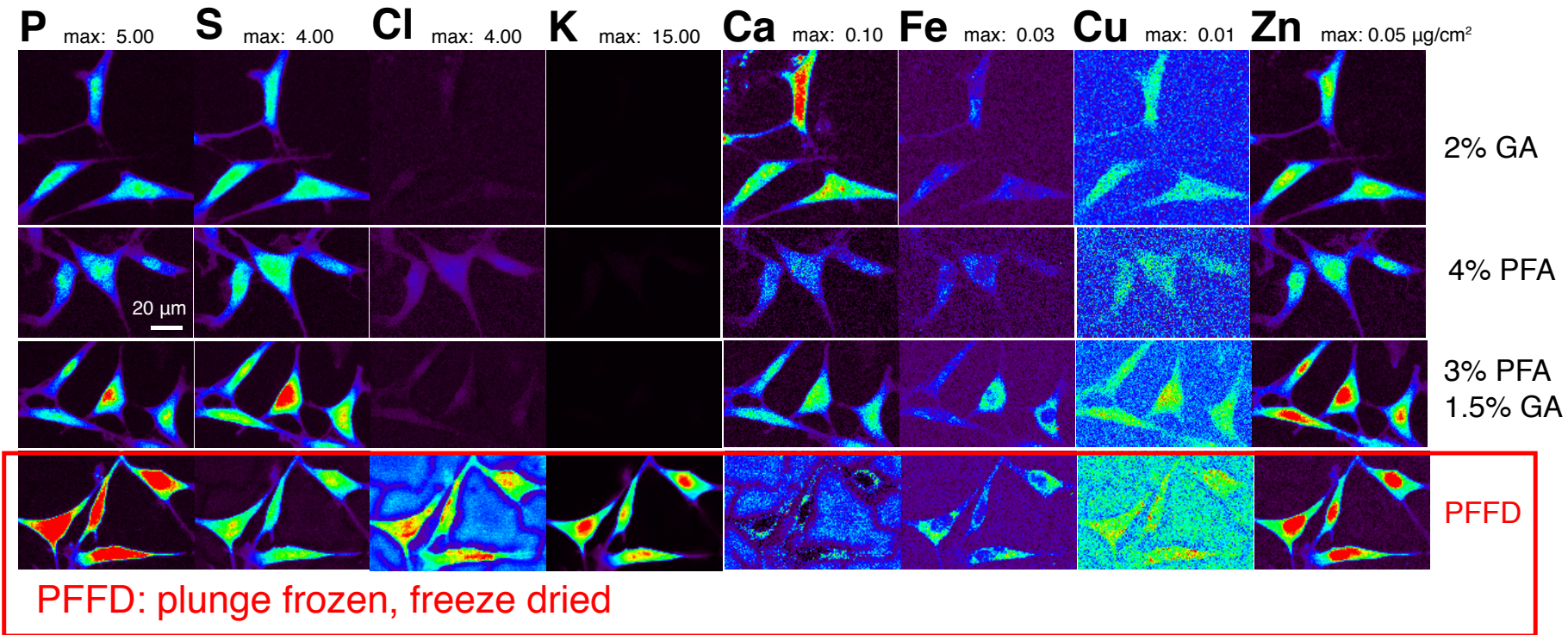

- Jin, Paunesku, Lai, Gleber, Chen, Finney, Vine, Vogt, Woloschak, and Jacobsen, *J. Microscopy* **265**, 81 (2017).
- See also Perrin, Carmona, Roudeau, and Ortega, *J. Analyt. Atom. Spectr.* **30**, 2525 (2015).

Radiation damage resistance in cryo microscopy

Frozen hydrated fibroblast image after exposing several regions to $\sim 10^{10}$ Gray

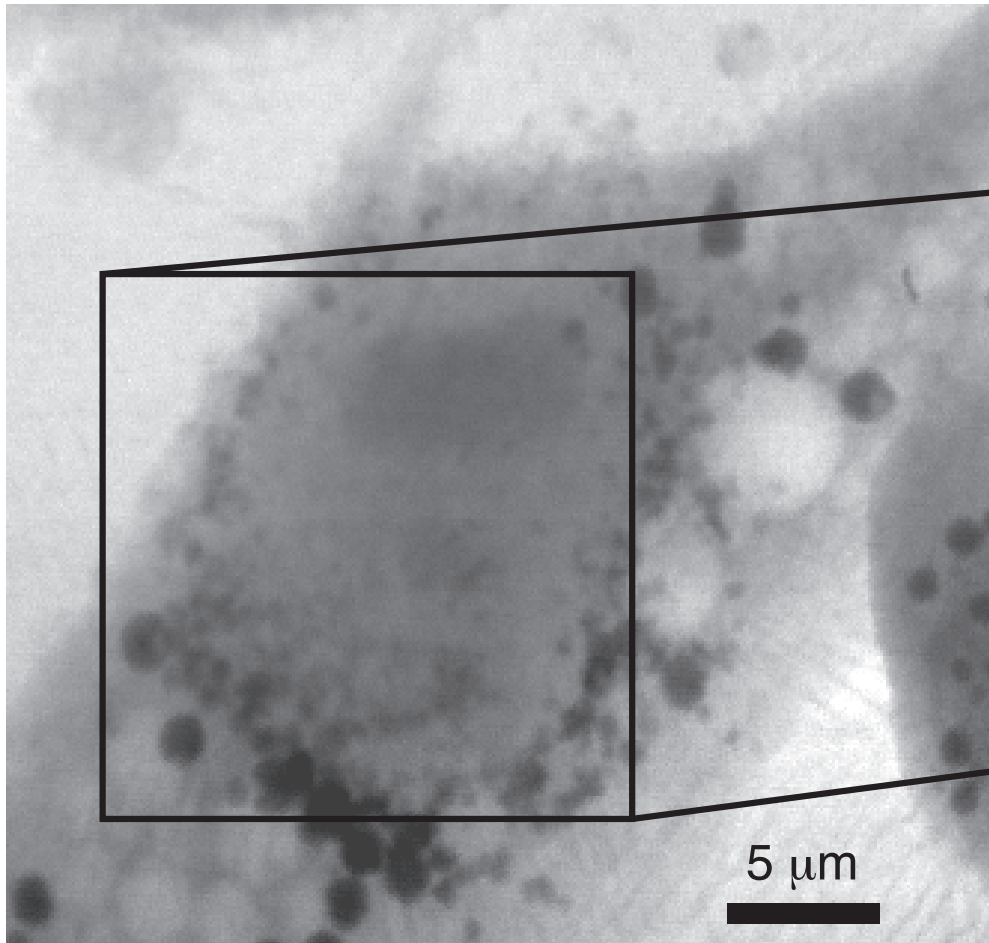

After warmup in microscope (eventually freeze-dried): holes at irradiated regions!

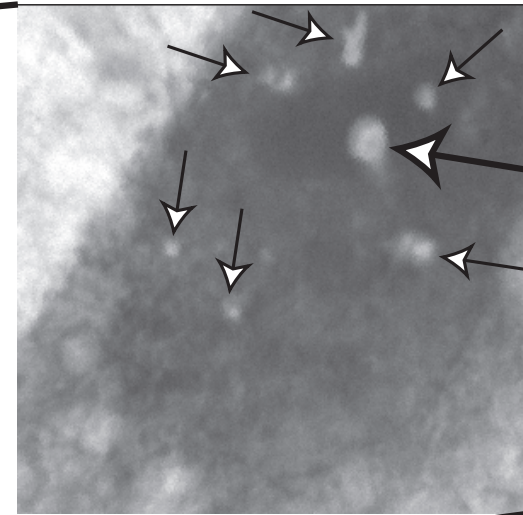

Maser *et al.*, *J. Microsc.* **197**, 68 (2000)

Radiation damage studies: poly (methyl methacrylate) or PMMA

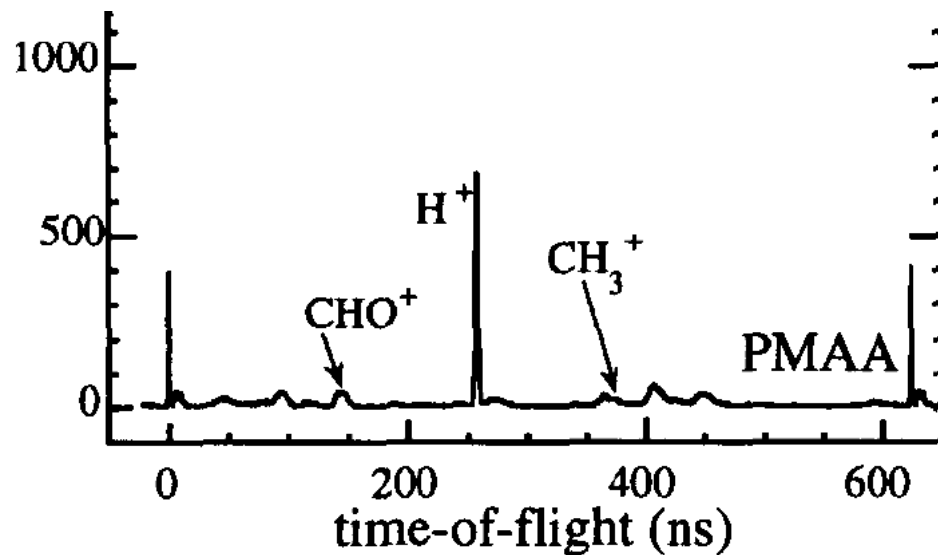
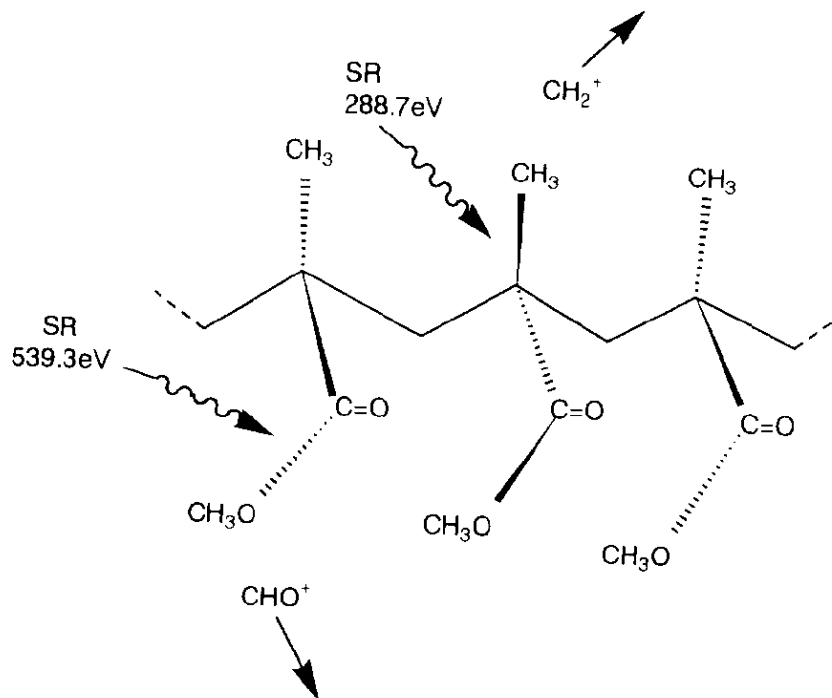

Tinone *et al.*, *Appl. Surf. Sci.* **79**, 89 (1994)

Tinone *et al.*, *J. Electron Spect. Rel. Phen.* **80**, 117 (1996).

PMMA at room, LN2 temperature

- Beetz and Jacobsen, *J. Synchrotron Radiation* **10**, 280 (2003)
- Repeated sequence: dose (small step size, long dwell time), spectrum (defocused beam)
- Images: dose region (small square) at end of sequence

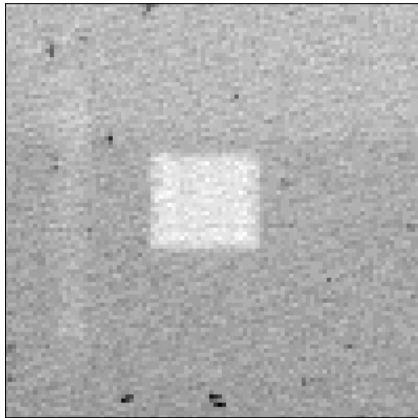

Room temperature:
mass loss immediately
visible

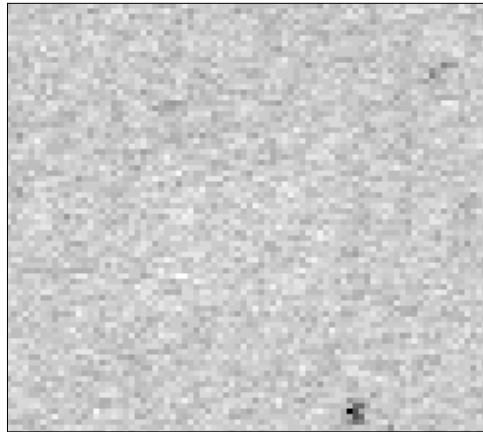

LN₂ temperature: no mass
loss immediately visible

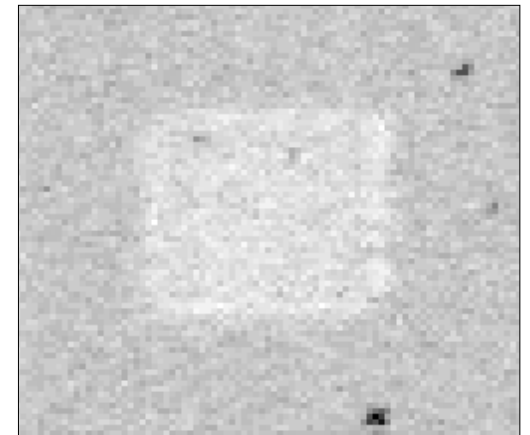

After warm-up: mass loss
becomes visible

Near-edge absorption fine structure (NEXAFS) or X-ray absorption near-edge structure (XANES)

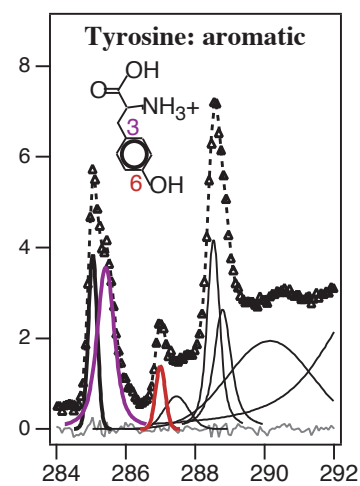
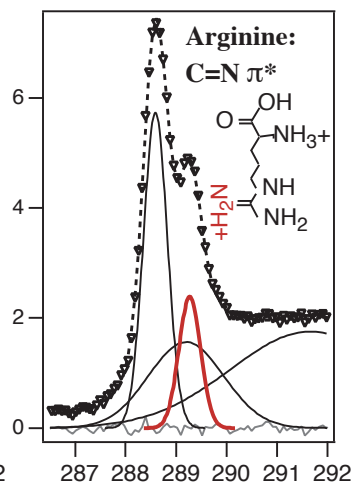
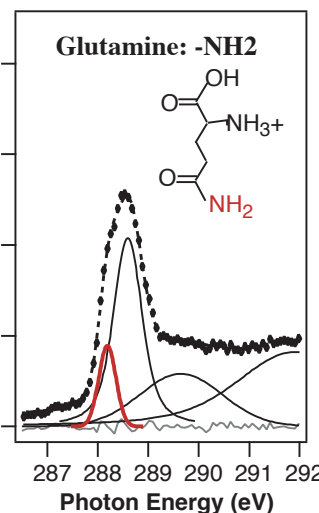
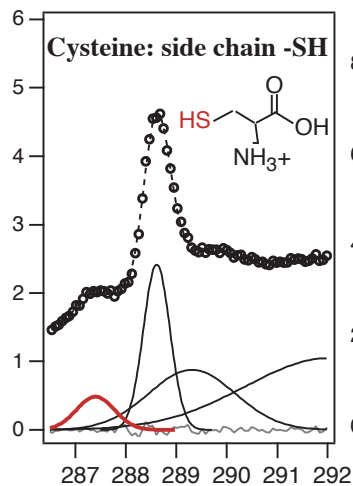
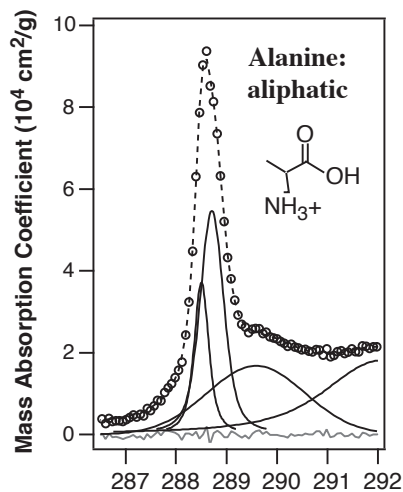
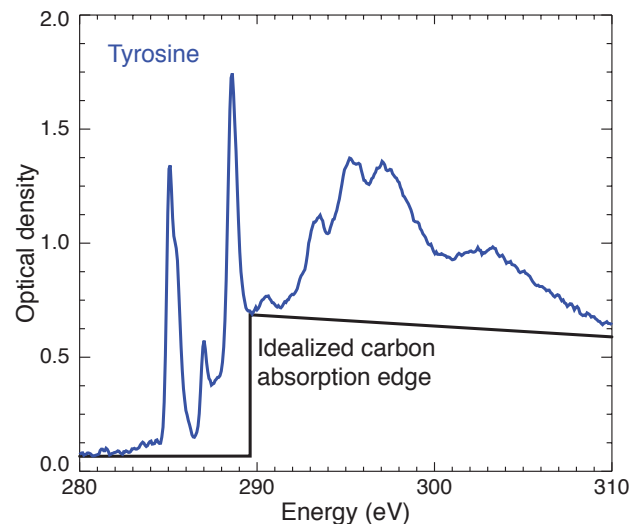
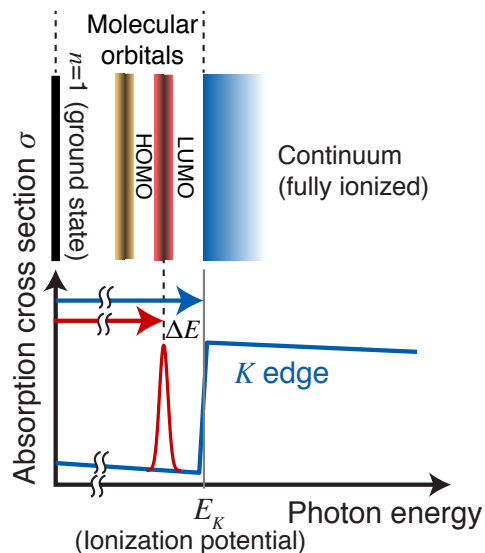

Amino acids example: K. Kaznatcheyev *et al.*, *J. Phys. Chem. A* **106**, 3153 (2002)

PMMA at 300 K and 110 K: chemistry and mass

LN₂ temp: protection against mass loss, but not against breaking bonds (at least C=O bond in dry PMMA)

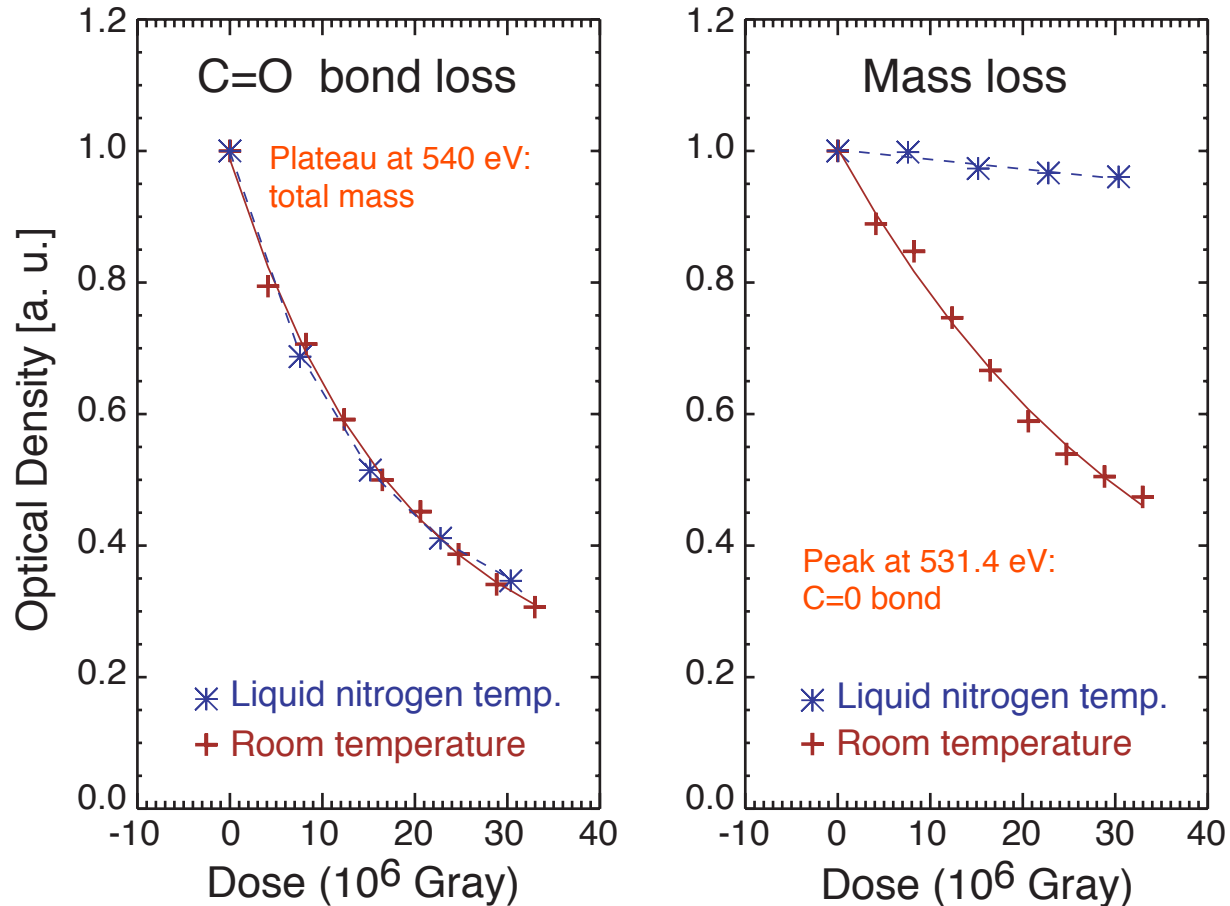

Beetz and Jacobsen, *J. Synchrotron Radiation* **10**, 280 (2003)

The Ramen noodle model of radiation damage



Macromolecular chains with no “encapsulating” matrix
(dry, room temperature wet)

The Ramen noodle model of radiation damage



Macromolecular chains in an “encapsulating” matrix
(frozen hydrated)

The Ramen noodle model of radiation damage



Actual noodles *were* harmed during the filming of this movie