

SYNCHROTRON RADIATION: PRODUCTION & PROPERTIES



DENNIS M. MILLS
Deputy Associate Laboratory Director
Advanced Photon Source

National School for Neutron and X-ray Scattering
July 2018

SOME BACKGROUND STUFF

SYNCHROTRON RADIATION - SOME BACKGROUND

Synchrotron Radiation (SR) - radiation from charged particles traveling in circular orbits - was first observed from a 70 MeV synchrotron at GE in Schenectady in 1947.

On April 24, [1947] Langmuir and I [Herbert Pollack] were running the machine... Some intermittent sparking had occurred and we asked the technician to observe with a mirror around the protective concrete wall. He immediately signaled to turn off the synchrotron as "he saw an arc in the tube." The vacuum was still excellent, so Langmuir and I came to the end of the wall and observed. At first we thought it might be due to Cerenkov radiation, but it soon became clearer that we were seeing Ivanenko and Pomeranchuk [i.e., synchrotron] radiation.

Excerpted from Handbook on Synchrotron Radiation, Volume 1a, Ernst-Eckhard Koch, Ed., North Holland, 1983.

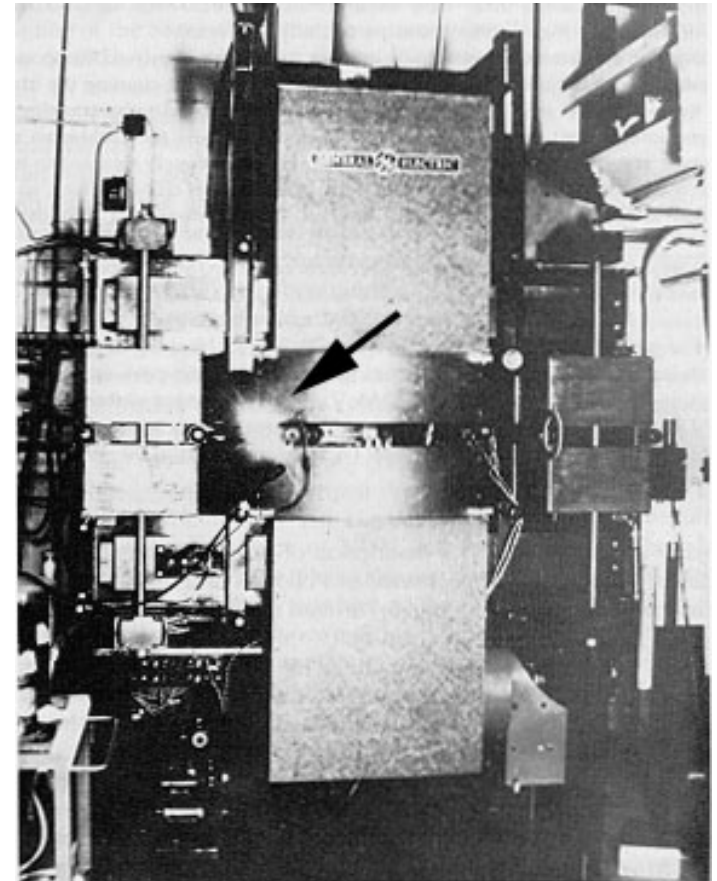

RADIATION PATTERNS FROM ACCELERATING CHARGES

Definitions:

$$\beta = v/c$$

$$\gamma = 1/\sqrt{1-\beta^2} = E/m_0c^2$$

When $v \ll c$, ($\beta \approx 0$), the shape of the radiation pattern is a classical dipole pattern.

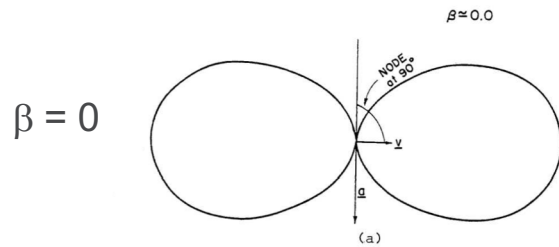

But as β approaches 1, the shape of the radiation pattern changes; it is more forward directed

$$\tan(\psi)_{lab} = \frac{\sin \psi'}{\gamma(\cos \psi' + \beta)} = \frac{1}{\gamma\beta} \approx \frac{1}{\gamma}$$

← Lorentz transformation

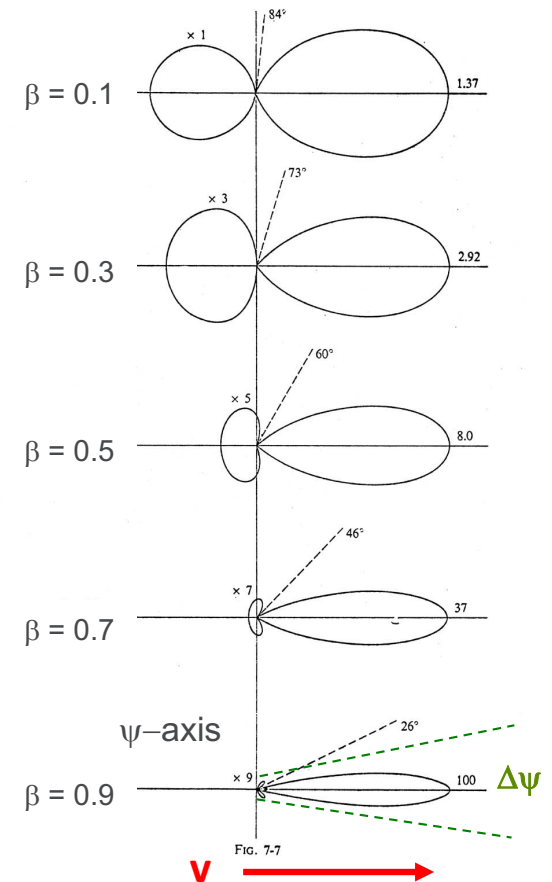

The angular divergence of the radiation (sometimes called the opening angle), $\Delta\psi$, is approximately $1/\gamma$.

RADIATION FROM HIGHLY RELATIVISTIC PARTICLES

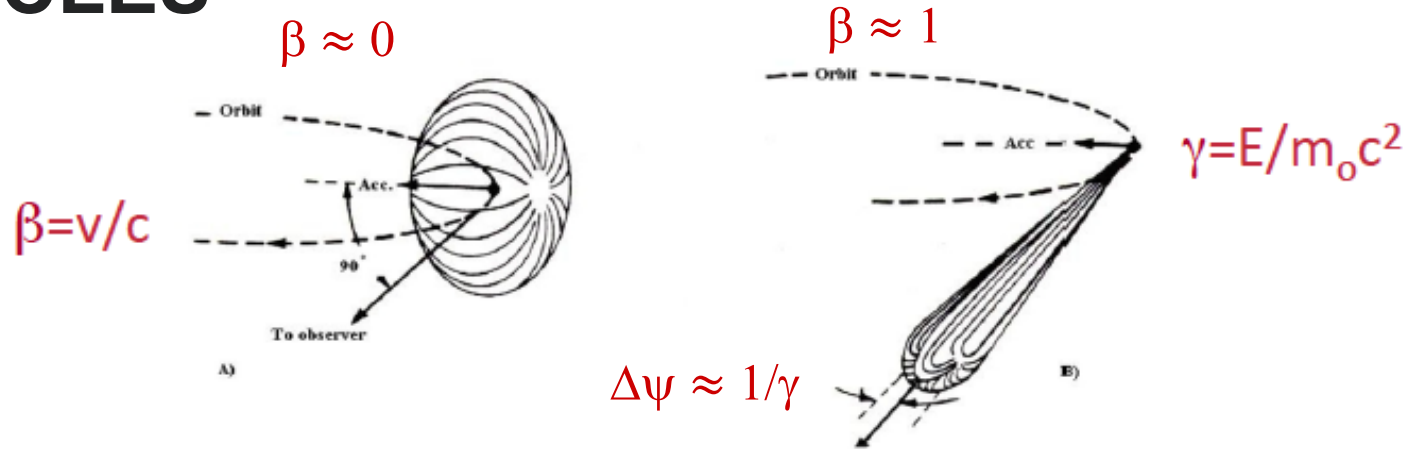

At the APS with $E = 7 \text{ GeV}$,
 $\gamma = E/m_0c^2 = 7 \text{ GeV}/0.511 \text{ MeV}$
 $\gamma = 1.4 \times 10^4$
 $1/\gamma = 73 \times 10^{-6}$

See Appendix 1 for more details

The opening angle in both the horizontal and vertical directions is given approximately by:

$$\Delta\psi_{\text{vert}} = \Delta\psi_{\text{hor}} \approx 1/\gamma,$$

when $\beta \approx 1$. (@ APS $\beta \approx 1 - 2 \times 10^{-9}$)

Relativistic velocities are good!!

- radiation forward directed
- radiated power $\propto E^4$

THE EVOLUTION OF X-RAY BRIGHTNESS FROM STORAGE RING SOURCES

- 1st Generation Sources
 - *Ran parasitically on accelerations for high- energy physics (CHESS and SSRL originally)*
- 2nd Generation Sources
 - *Built to optimize synchrotron radiation from the bending magnets (NSLS)*
- 3rd Generation Sources
 - *Built to optimize synchrotron radiation from insertion devices (ALS, APS, NSLS II)*
- 3.5 (?) Generation Sources
 - *Based on multi-bend achromat (MBA) storage ring lattices to go towards a diffraction-limited source (ALS-U, APS-U) (more later)*
- 4th Generation Sources
 - *fully coherent sources*
 - *X-ray Free Electron Lasers - X-FELs (LCLS)*
 - *Diffraction Limited Storage Rings (DLSRs)*

History of (8-keV) X-Ray Sources

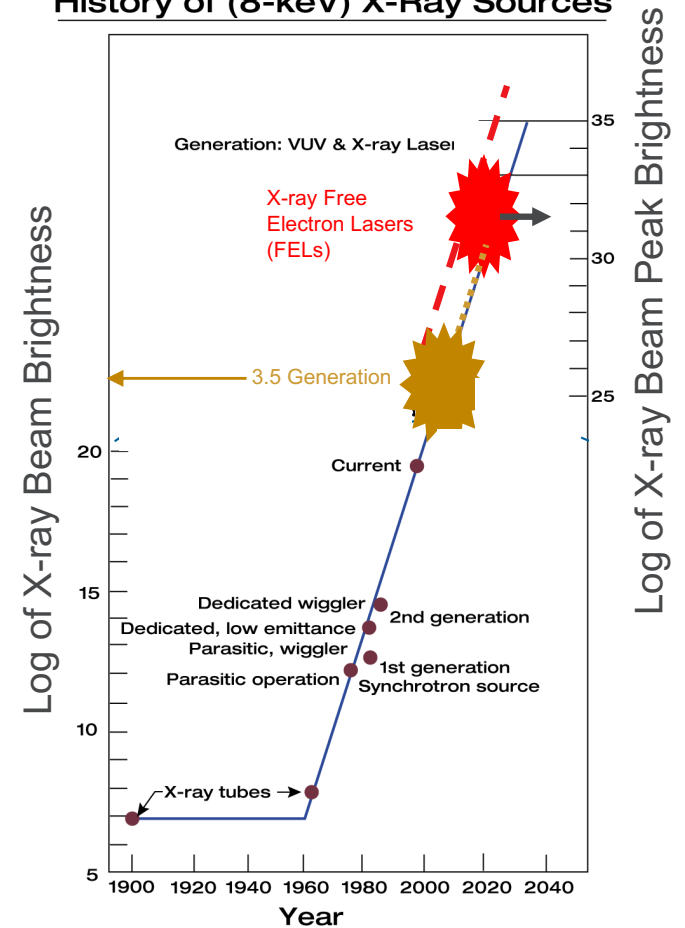

A VITAL NATIONAL RESOURCE FOR SCIENCE AND TECHNOLOGY

ALS, APS, NSLS, SSRL & LCLS are funded by the Department of Energy, Office of Science, Basic Energy Science (DOE/BES).

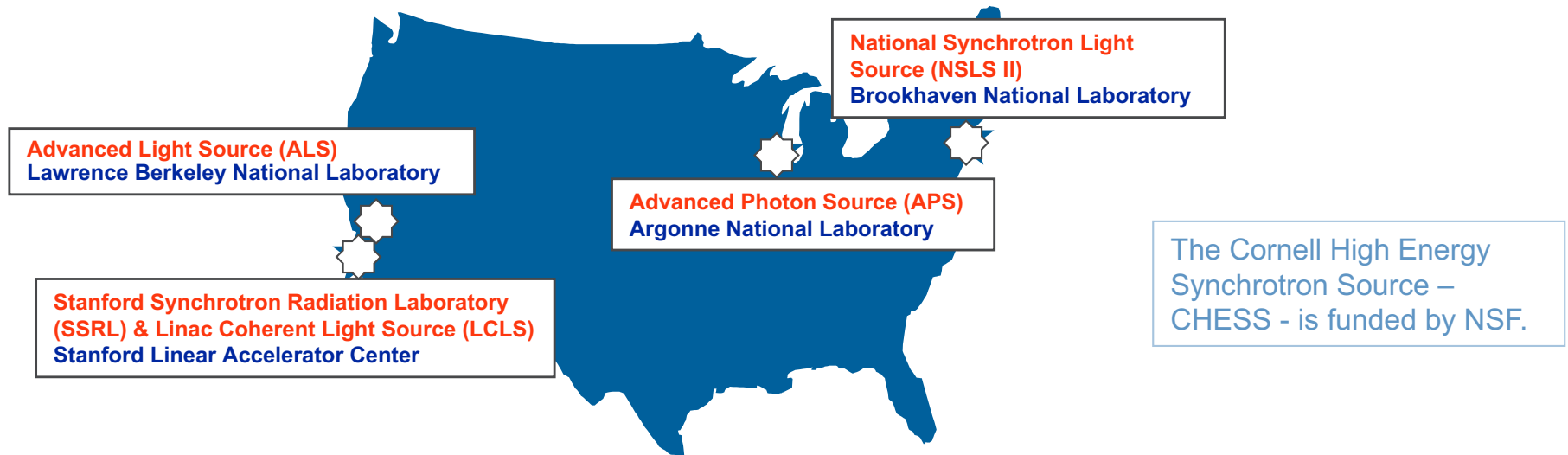

Over **5700 unique researchers** from around the world came to Argonne last year to perform experiments at the APS.

DOE/BES also operates several neutron user facilities as well as the nanoscience research centers.

ANATOMY OF SYNCHROTRON RADIATION FACILITY

ADVANCED PHOTON SOURCE BEAM ACCELERATION & STORAGE SYSTEM

(A) ELECTRON GUN

(B) ELECTRON LINEAR ACCELERATOR

Output energy: **375 MeV**

(C) PARTICLE ACCUMULATOR RING

(D) BOOSTER SYNCHROTRON

Nominal extraction energy: **7.0 GeV**

(E) STORAGE RING

Nominal energy: **7.0 GeV**

(E1) INSERTION DEVICE

(E2) BENDING MAGNET

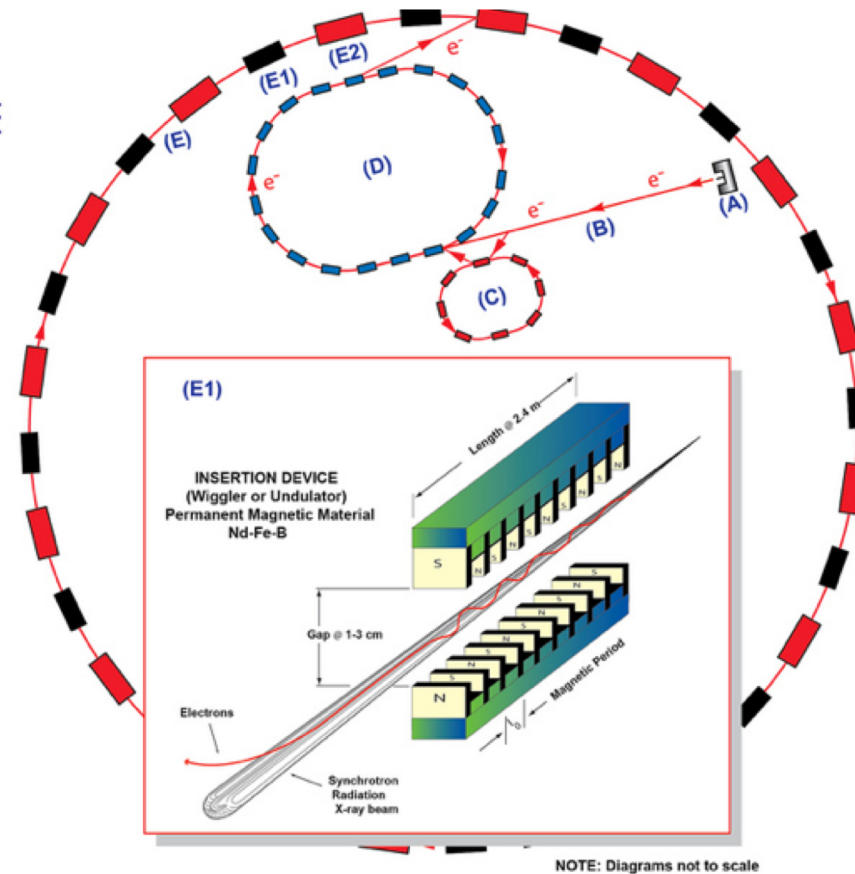

PROPERTIES OF THE X-RAYS

BEND MAGNET X-RAY PROPERTIES

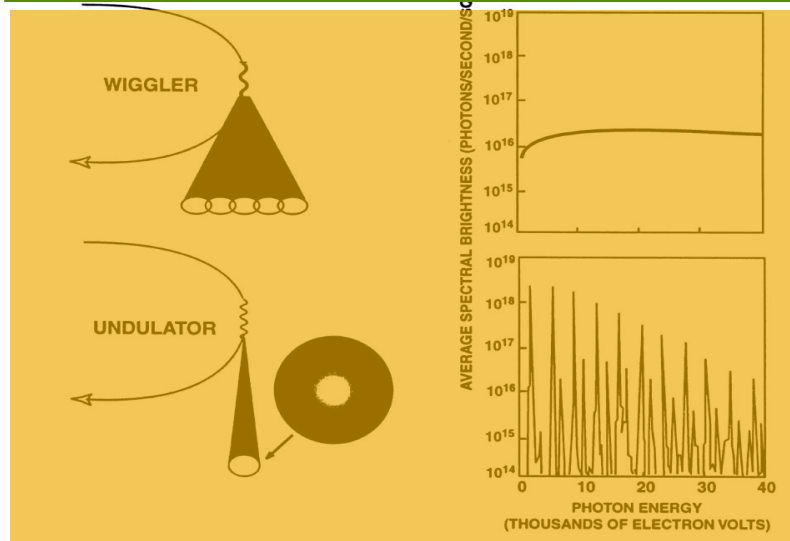
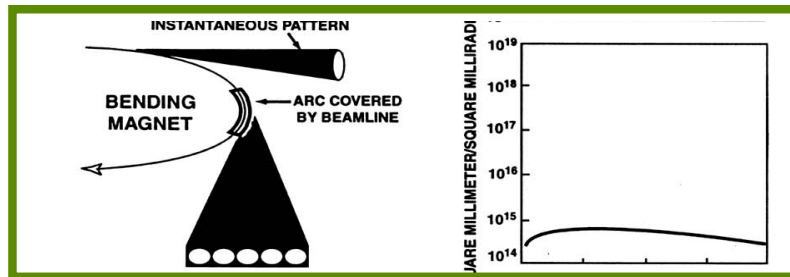

See Appendix 2 for more details

Bend Magnet Radiation

Spectrum characterized by the critical energy:

$$E_c = 3hc\gamma^3/4\pi r \quad (E_c \approx 20 \text{ keV @ APS})$$

$$E_c[\text{keV}] = 0.066 B[\text{kG}] E^2 [\text{GeV}]$$

Recall: $\lambda[\text{\AA}] = 12.4/E[\text{keV}]$ so 20 keV is 0.62\AA

Vertical opening angle ($\Delta\psi_v$) is $1/\gamma$. *At the APS:*

$$\gamma = 1.4 \times 10^4$$

$$\text{so } 1/\gamma = 73 \times 10^{-6} \text{ radians}$$

Horizontal opening angle determined by apertures.

In the plane of the orbit, the polarization is linear and parallel to the orbital plane.

PLANAR INSERTION DEVICES

- Insertion devices (IDs) are periodic magnetic arrays with alternating field directions that force the particles to oscillate as they pass through the device.
- “Planar” refers to the magnetic field being in one direction (in this case vertical or y-direction).
- IDs can have fields in both the vertical and horizontal directions to produce circularly polarized x-rays and for other applications.

INSERTION DEVICE (WIGGLER OR UNDULATOR) PERMANENT MAGNETIC MATERIAL Nd-Fe-B

The strength of the magnetic field, B , is varied by changing the gap between the permanent magnets in the upper and lower halves of the insertion device.

Beam of electrons continues around the ring being bent by the bending magnets (not shown for clarity).

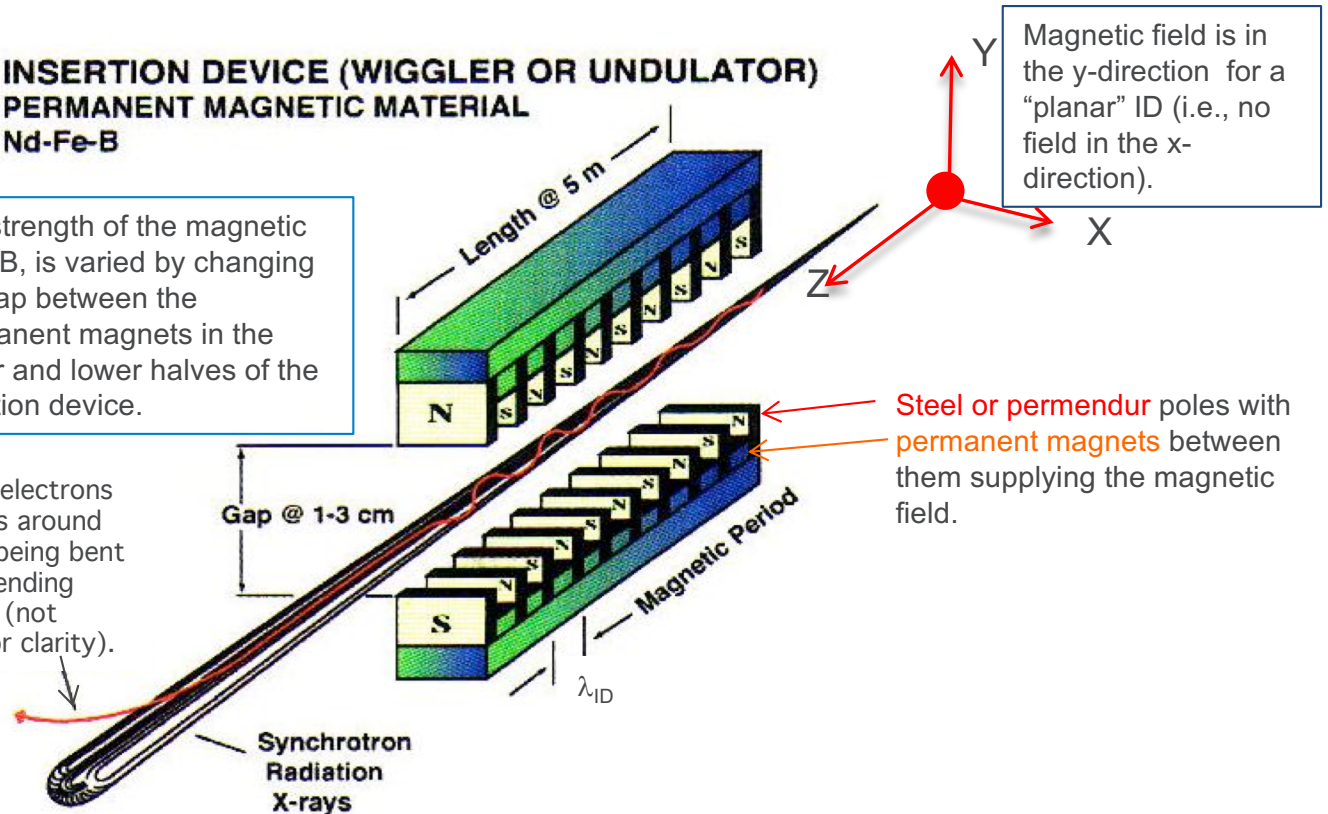

CHARACTERIZING INSERTION DEVICES

See Appendix 3 for
more details

- IDs are characterized by the so-called field index or deflection parameter, K

$$K = eB_0\lambda_{ID}/2\pi m_0c = 0.0934 \lambda_{ID}[\text{cm}] B_0[\text{kG}]$$

where λ_{ID} is the period of the insertion device and B_0 the peak magnetic field. (The length of the insertion device, L , is equal to the number of periods, N , times the length of the period, i.e., $L = N\lambda_{ID}$.)

- The maximum deflection angle of the particle beam, θ_{\max} , is given by:

$$\theta_{\max} = \pm(K/\gamma)$$

and the amplitude of the oscillation of the particles, x_{\max} , by:

$$x_{\max} = (K/\gamma)(\lambda_{ID}/2\pi)$$

*APS Undulator A has a period of
3.3 cm and operates with $K \approx 1$,
therefore:*

$$\theta_{\max} \approx 1/\gamma$$

$$x_{\max} \approx 0.38 \text{ microns.}$$

WIGGLER RADIATION PATTERN & SPECTRUM

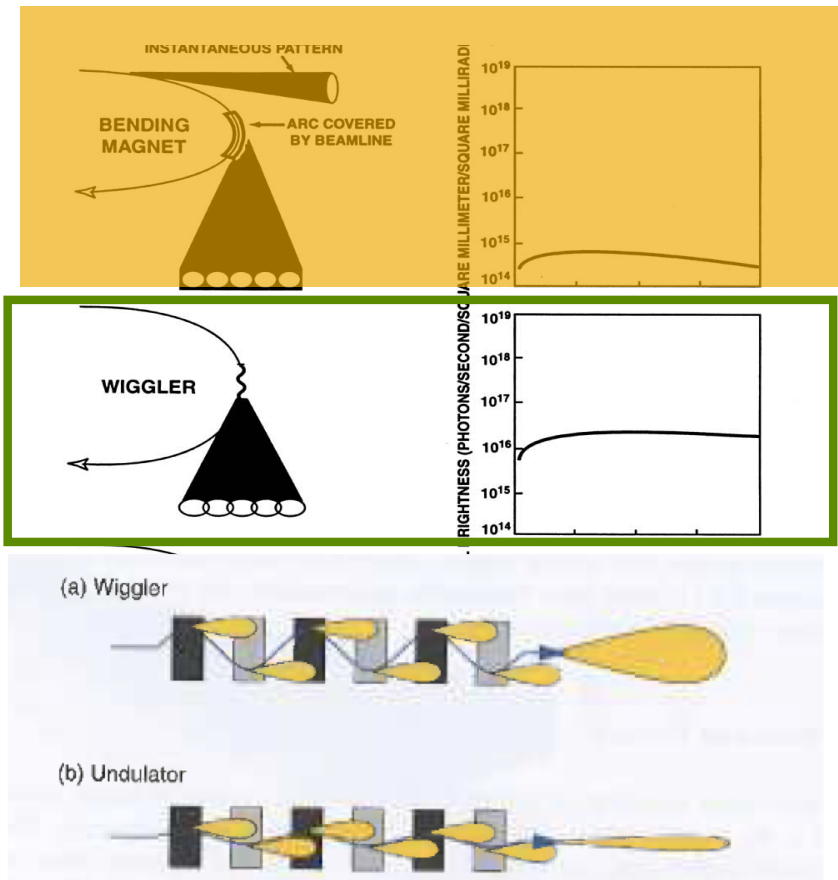

Wiggler Radiation ($K \gg 1$)

- Radiation spectrum looks like $2N$ dipole sources (N = number of periods)
- $\theta_{\max} = (K/\gamma) \gg 1/\gamma$, i.e. the angular deflection of the particle beam is much greater than the natural opening angle of the radiation ($1/\gamma$).
- Spectrum characterized by the critical energy (which may be different than BM critical energy)
- **Presently, there are NO planar wigglers installed at the APS because they lack the brightness of undulators. (see next slides)**

UNDULATORS

Undulators ($K \approx 1$)

- θ_{\max} ($= K/\gamma$) is comparable ($1/\gamma$) and so the radiation from each pole overlaps.
- If the magnetic field is carefully designed, this overlap can cause interference effects in the spectral distribution.
- On-axis ($\psi_v = \psi_H = 0$), the constructive interference occurs at a particular x-ray wavelength ($\lambda_n^{\text{x-ray}}$) and its odd harmonics, i.e. $n = 1, 3, 5 \dots$ when:

$$\lambda_n^{\text{x-ray}} = (\lambda_{\text{ID}}/2\gamma^2 n)(1 + K^2/2)$$

- The wavelength, $\lambda_n^{\text{x-ray}}$, where constructive interference occurs, can be adjusted by varying the magnet field, B , of the undulator since $K = 0.093 \lambda_{\text{ID}}[\text{cm}] B_0[\text{kG}]$.
- Since most undulators are made with permanent magnets, the B-field is changed by changing the gap between the magnets.

APS 2.4 m long Undulator A ($\lambda_{\text{ID}} = 3.3$ cm) Permanent magnets

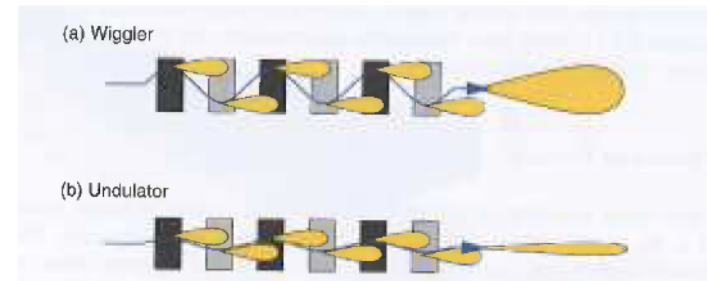
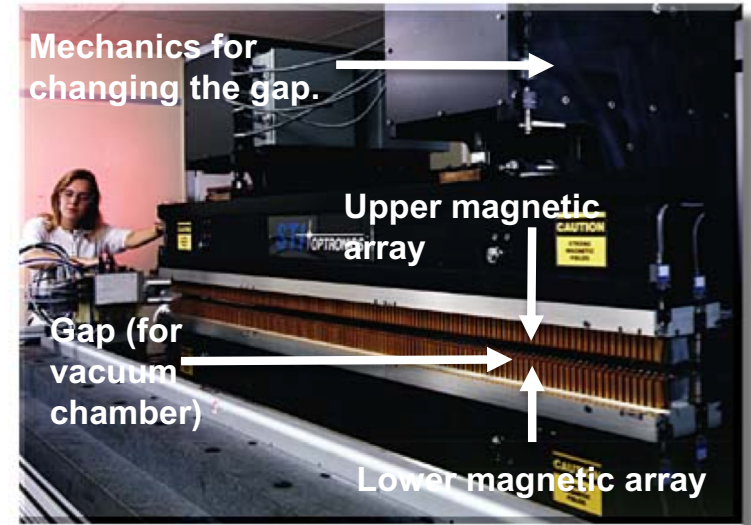

UNDULATOR RADIATION SPECTRA

Undulator Radiation ($K \approx 1$)

- The spectrum from an undulator is spikey, but peaks are tunable in energy by varying K since $K \propto B[\text{kG}] \lambda_{\text{ID}}[\text{cm}]$.
- At the fundamental (1st harmonic), the horizontal and vertical opening angles of the radiation is given by:

$$\Delta\psi_V = \Delta\psi_H \approx (1/\gamma) [1/N]^{1/2}$$

where N = number of periods [typically 100 or so]

- To get the observed opening angle of the emitted radiation, need to consider the angular properties of the emitting particles (more later on!)

See Appendix 4 for more details

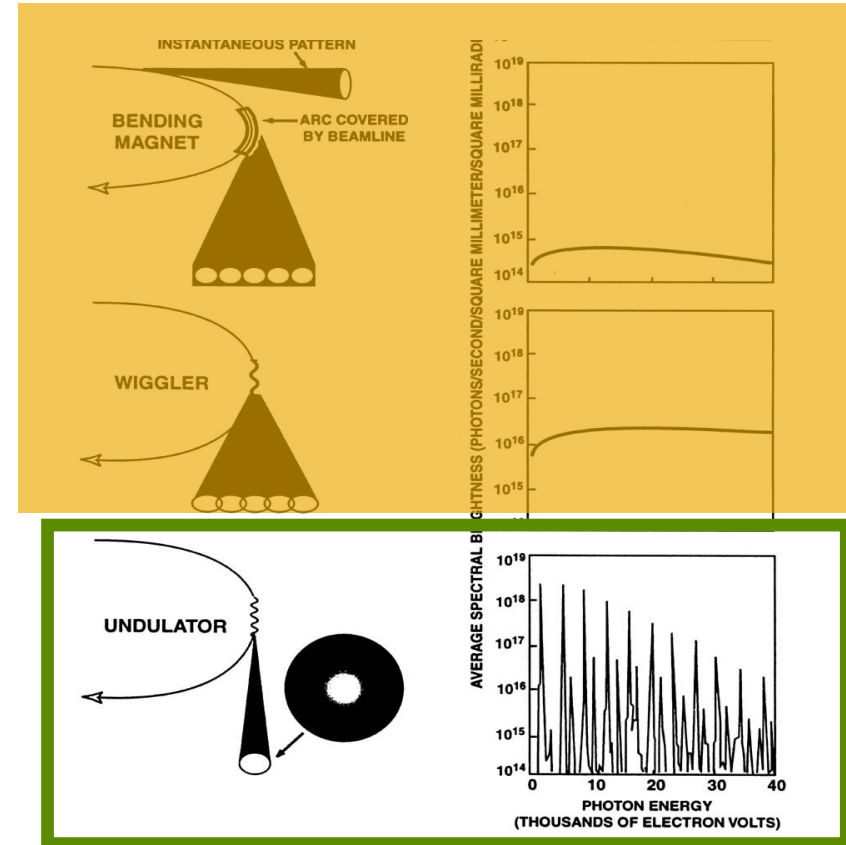

TUNING THE PEAKS OF UNDULATOR RADIATION

The wavelength where constructive interference $\lambda_n^{\text{x-ray}}$, can be adjusted by changing the K value of the undulator.

$$\lambda_n^{\text{x-ray}} = (\lambda_{ID}/2\gamma^2n)(1 + K^2/2)$$

$$K = 0.093 B[\text{kG}] \lambda_{ID}[\text{cm}]$$

The low energy is usually fixed by the minimum magnet gap (determined by the vacuum chamber). As the gap is opened, K gets smaller and the x-ray energy increases, but as you open it further, the magnetic field decreases and so does the intensity of the x-rays.

Here is the **spectrum for a particular K value** (i.e., a particular gap for PM devices or current in SC devices).

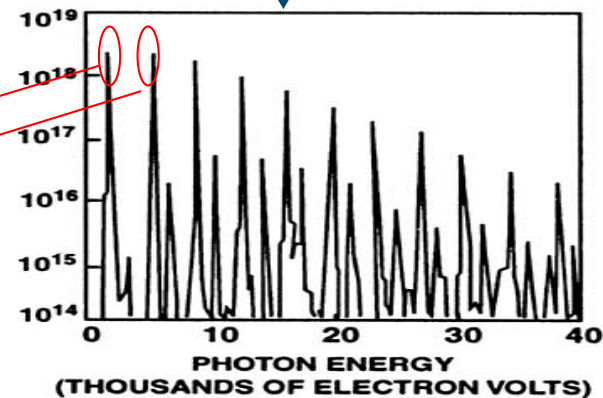
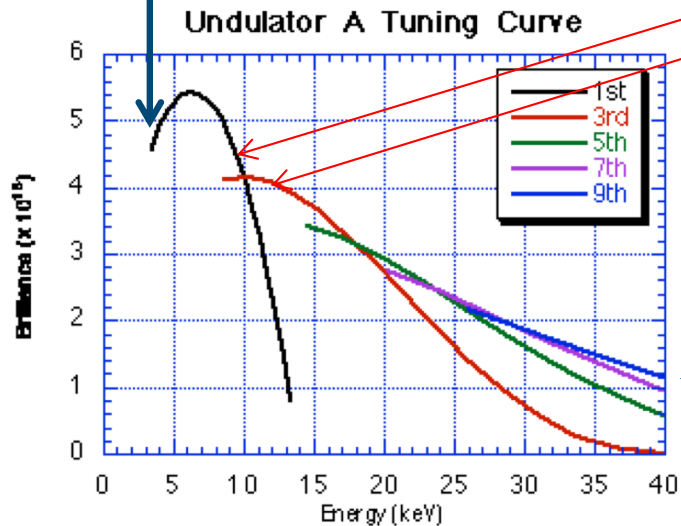

Plots like this that show the energy range that can be covered by an undulator are often called “**tuning curves**”.

SUPERCONDUCTING UNDULATORS

- There is a strong desire at the APS to increase x-ray energy of the 1st harmonic.

$$\lambda_n^{\text{x-ray}} = (\lambda_{\text{ID}}/2\gamma^2n)(1 + K^2/2)$$

- One way to do this is to go to shorter ID periods, i.e., reduce λ_{ID} .
- That is difficult to do with PMs as there is less room for the magnetic material.
- Room temp electromagnets cannot produce the necessary fields at short periods, but superconducting electromagnets can.



SCU1

- 18 mm period
- 1.1 m long
- 9.5 mm gap
- 0.6 mm NbTi conductor

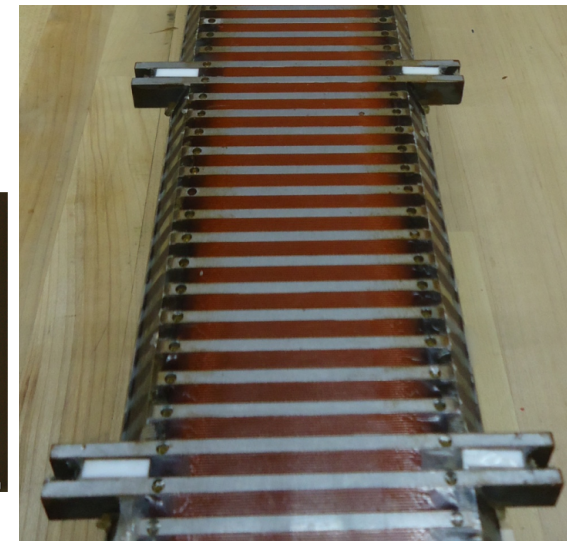
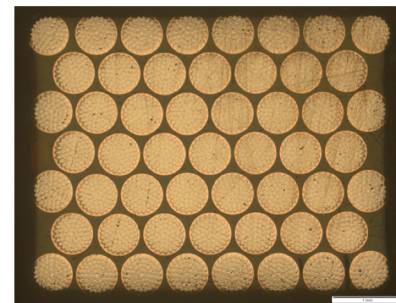

PROPERTIES OF THE ELECTRON BEAM

TRANSVERSE PROPERTIES OF PARTICLE BEAMS

- Up until now, we have calculated the radiation properties from a single electron, however in a storage ring, the radiation is emitted from an ensemble of electrons with some finite size and divergence.
- Both the transverse and longitudinal properties of the particle beam in a storage ring are the equilibrium properties of the particle beam, but here we are interested in the *transverse* properties.
- Accelerator physicists describe the electron beam in terms of horizontal (x-plane) and vertical (y-plane) **phase space**.

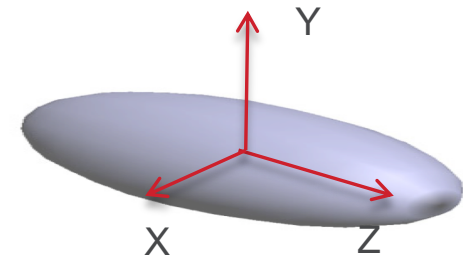

X, Y are transverse directions
Z is the longitudinal direction

- Typical coordinates for a phase space plot are conjugate variables like momentum (P_x) and position (X).



- For relativistic electrons, P_x is proportional to X' and so phase space plots will be

X vs X' (or Y vs Y').

Remember: this plot is not the beam cross-section, but a phase space representation!!!

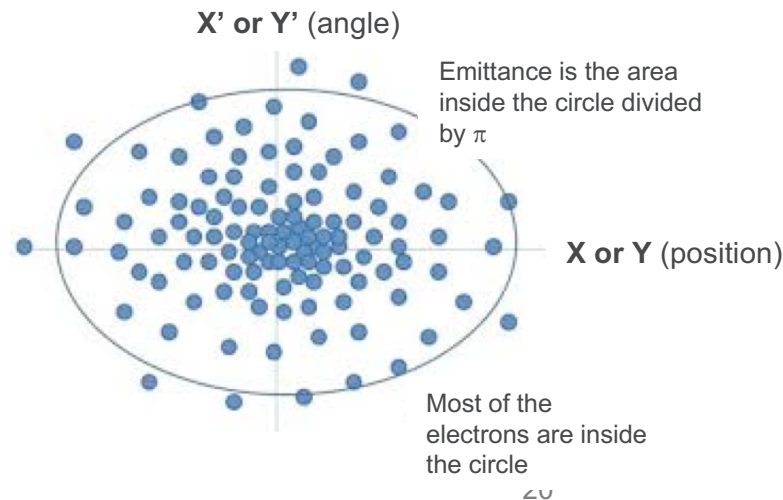

ELECTRON BEAM PHASE SPACE AND EMITTANCE

- The product of the particle beam size and divergence is proportional to a parameter of the electron beam called the **emittance** (units are **length x angle**).
- The formal definition is that the emittance is the (elliptical) phase space area occupied by the system of particles divided by π .
- There is a separate horizontal emittance (ϵ_x) and vertical emittance (ϵ_y). Typically in today's storage rings:

ϵ_y is 1% to 10% of ϵ_x (called the coupling)

- The **emittance is a constant of the storage ring**, although one can trade off electron beam size for divergence as long as the area of the phase-space remains constant.

This is a consequence of Liouville's Theorem – the conditions for which are satisfied in most accelerators.

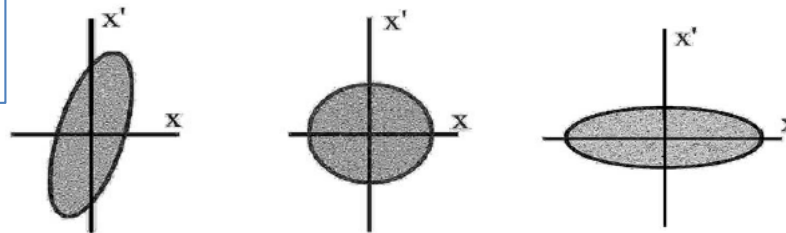

$$\epsilon_H = 3 \times 10^{-9} \text{ m-rad @ APS}$$

and

$$\epsilon_V = 0.03 \times 10^{-9} \text{ m-rad.}$$

WHY DO WE NEED TO KNOW ABOUT THE TRANSVERSE ELECTRON BEAM PROPERTIES?

- Although the flux from undulators can be determined without detailed knowledge of the source size and divergence, one very important characteristic of the x-ray beam, namely **brightness**, requires a more detailed knowledge of the particle beam's size and divergence.

Brightness has units of: photons/sec/0.1% BW/source area/source solid angle

$$\text{Flux} / 4\pi^2 \Sigma_h \Sigma_v \Sigma_h' \Sigma_v'$$

where Σ_i (Σ_i') is the **effective** one sigma value of the source size (divergence) in the i^{th} direction. If Gaussian distributions are assumed for both the electron beam and the radiation itself, the resultant source size and divergence is the quadrature sum of the two components, namely:

$$\Sigma_i = [\sigma_r^2 + \sigma_i^2]^{1/2} \quad \text{and} \quad \Sigma_i' = [\sigma_r'^2 + \sigma_i'^2]^{1/2}.$$

The diagram illustrates the quadrature sum of radiation and electron beam properties. On the left, the equation $\Sigma_i = [\sigma_r^2 + \sigma_i^2]^{1/2}$ is shown. Below it, two boxes labeled 'radiation beam size' and 'electron beam size (i= x or y)' have arrows pointing up to the σ_r^2 and σ_i^2 terms respectively. In the middle, the word 'and' is placed. On the right, the equation $\Sigma_i' = [\sigma_r'^2 + \sigma_i'^2]^{1/2}$ is shown. Below it, two boxes labeled 'radiation beam divergence' and 'electron beam divergence (i= x or y)' have arrows pointing up to the $\sigma_r'^2$ and $\sigma_i'^2$ terms respectively.

- When the electron emittance decreases then brightness increases until the emittance reaches the diffraction limit for a given x-ray wavelength.

DIFFRACTION LIMITED SOURCES AND COHERENCE

- The Heisenberg Uncertainty Principle sets a lower limit for the emittance of radiation. Recall:

$$\Delta x \Delta p_x \geq \hbar / 2$$

$$\frac{p_x}{p_z} = x' \text{ or } \frac{\Delta p_x}{p_z} = \Delta x' \text{ and } p_z = \hbar k = \frac{\hbar(2\pi)}{\lambda}$$

$$\text{so: } \Delta x \Delta p_x = \Delta x \Delta x' p_z = \Delta x \Delta x' \left[\frac{\hbar(2\pi)}{\lambda} \right] \geq \hbar / 2$$

$$\Delta x \Delta x' \geq \lambda / 4\pi$$

- If both the horizontal and vertical emittance of the beam is less than $\lambda/4\pi$, then the radiation emitted is **fully coherent and the source is diffraction limited**. For 1Å (12 keV) x-rays, the electron beam emittance would have to be less than:

$$1\text{\AA} / 4\pi = 10^{-10} \text{ meters} / 4\pi \approx 8 \times 10^{-12} \text{ m or}$$

8 picometers – radian (radians are dimensionless)

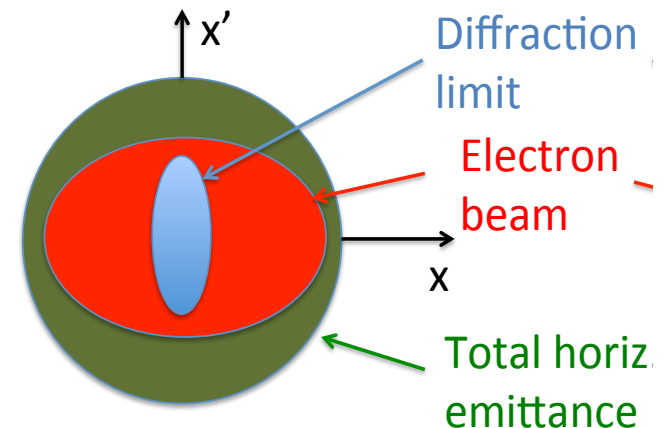

PARTIALLY COHERENT SOURCES

- For 1Å (12 keV) x-rays → 8 picometers – radian for fully coherent beam. APS operates with:

$$\varepsilon_H = 3 \times 10^{-9} \text{ m-rad or } 3000 \text{ picometer-radian}$$

$$\varepsilon_V = 0.025 \times 10^{-9} \text{ m-rad or } 25 \text{ picometer-radian}$$

- Hence the APS is a partially coherent source at 1 Å.
- Partially coherent sources are sometimes characterized by the coherent fraction.
 - Coherent fraction = ratio of diffraction-limited emittance to actual beam emittance, or = the fraction of the x-ray flux that is coherent.
- For the APS at 1Å, the coherent fraction is $\approx 10^{-3}$. This value is marginally good enough for coherence-based experiments so the trend is to try to reduce the particle beam emittance to increase coherence.
- Why not just squeeze the electron beam tighter in the existing storage ring? The present bend magnet configuration limits *emittance*:
 - Need stronger focusing magnetic fields than can be reached with present electron beam energy and size of the storage ring vacuum chamber
 - Intra-bunch scattering of the particles results in beam loss and shorter lifetimes

NEXT GENERATION LIGHT SOURCES

A MULTI-BEND ACHROMAT LATTICE AT APS

$$\varepsilon_x = C_L \frac{E^2}{N_D^3}$$

$C_L = \text{constant}$
 $E = \text{beam energy}$
 $N_D = \text{dipoles per sector}$

APS MBA Upgrade:

Beam energy: 7 GeV \Rightarrow 6 GeV

Dipoles per sector: 2 \Rightarrow 7

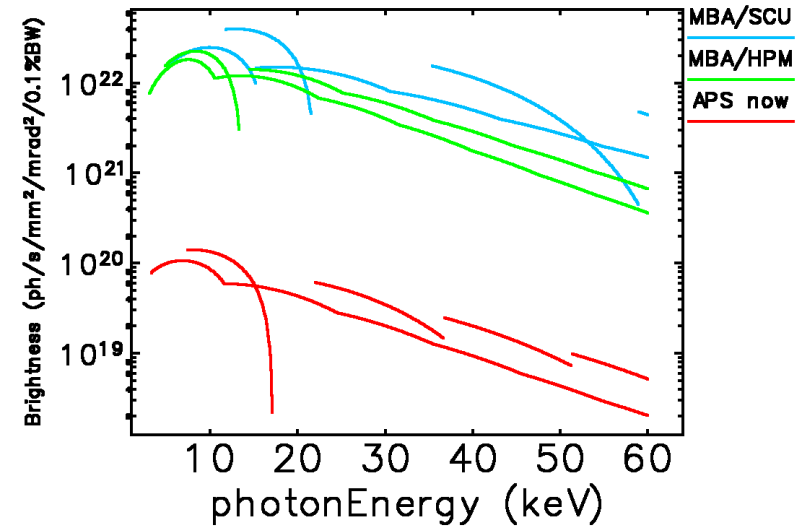

~50-fold
reduction in
horizontal
emittance

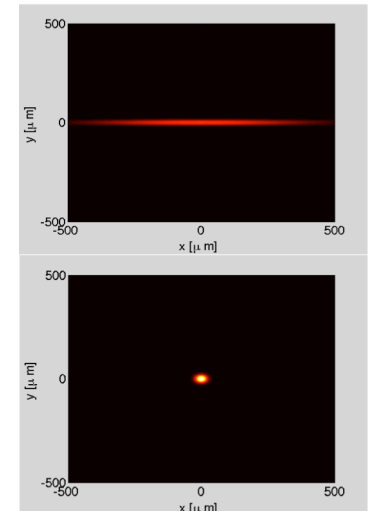
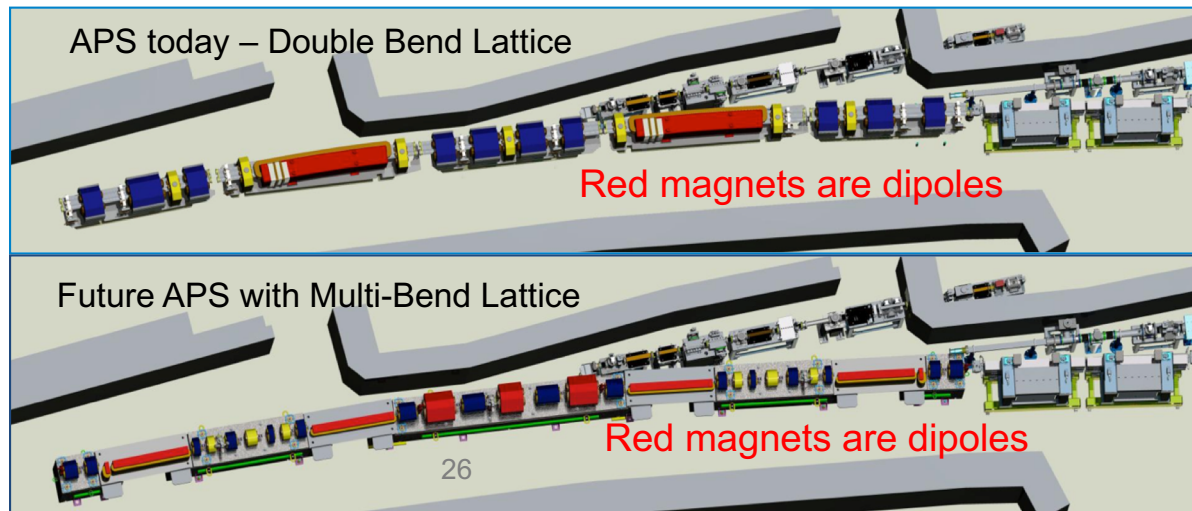

SMALL VACUUM CHAMBERS AND BUNCH LENGTHENING

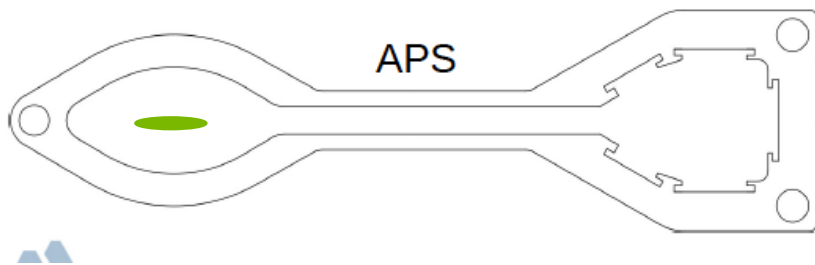

APS-U Concepts
Vacuum chamber

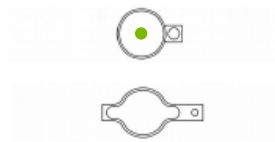

Figures courtesy B. Stillwell (ANL).

reduce size of the vacuum chamber for higher magnetic fields for focusing

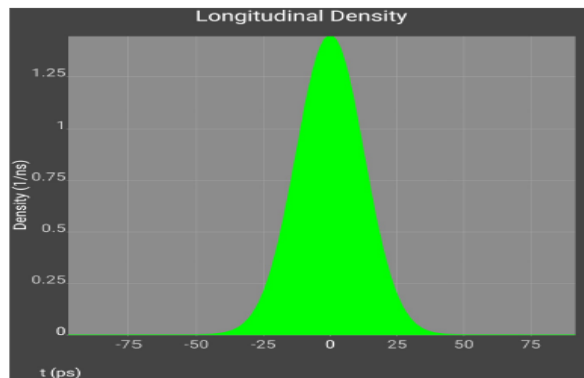

Stretch the bunch with rf cavities

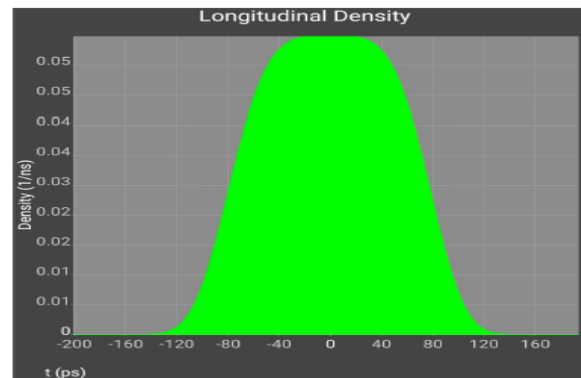

lengthen the bunch longitudinally to reduce particle density

MBA UPGRADES – A COMPETITIVE LANDSCAPE

ESRF (France)

- ESRF will shut down at the end of 2018 to resume operation in 2020, complete four state-of-the-art beamlines by 2022.

MAX-IV (Sweden)

- Operational

SIRIUS (Brazil)

- Completing final design; accelerator begins commissioning in 2018 and operational in 2020.

SPRING-8 (Japan)

- Capable of upgrading in 2020's

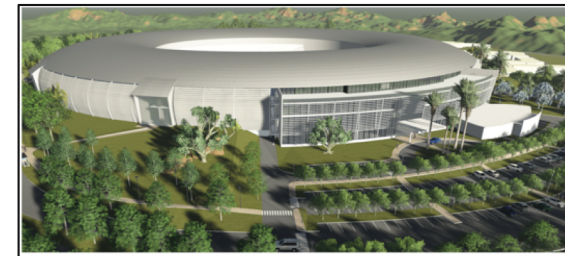

NON-STORAGE RING COHERENT X-RAY SOURCES – X-RAY FREE ELECTRON LASERS (XFELs)

- Another way to reduce the particle beam emittance is through linac-based x-ray free electron lasers (XFELs)
 - Full transverse (spatial) coherence and femtosecond pulses
- An **x-ray FEL** uses the high brightness of an **electron gun** coupled to an **emittance-preserving linac**.
- The problem with a linac is you only use the electrons once, and so have to accelerate new electrons for each pulse (in the storage ring you “recycle” the electrons after they have been accelerated).
- The gain in the laser is obtained through a process called **Self-Amplified Spontaneous Emission** or **SASE**.

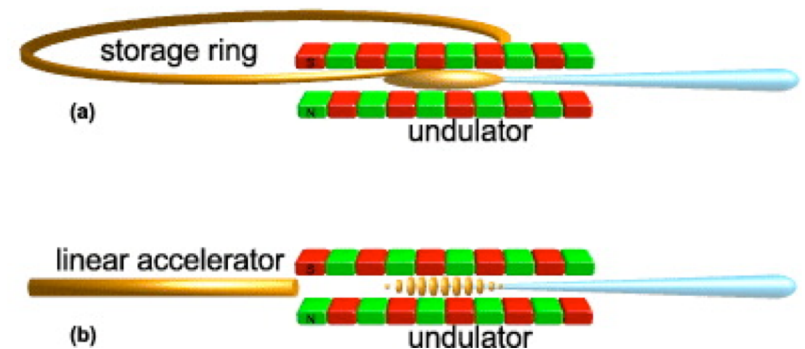

SELF-AMPLIFIED SPONTANEOUS EMISSION – SASE

- In this process, an intense and highly collimated electron beam travels through an undulator magnet.
- The alternating north and south poles of the magnet force the electron beam to emit **synchrotron radiation** as it goes.

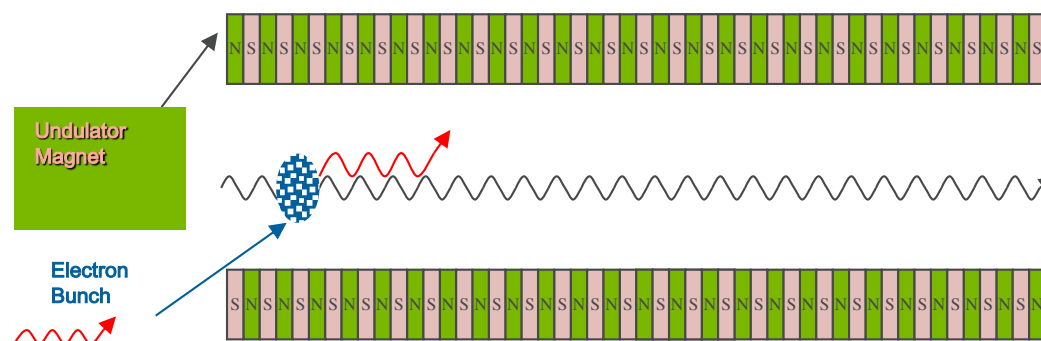

Linac Coherent Light Source (LCLS) at SLAC is an x-ray FEL using 1 km of the 3 km linac there to produce 15 Å to 1.5 Å beams.

ENERGY MODULATION → DENSITY MODULATION (MICRO-BUNCHING)

- In this process, an intense and highly collimated electron beam travels through a long undulator magnet (≈ 100 meters).
- If the synchrotron radiation is sufficiently intense (i.e., the undulator is long enough), the electron motion is modified by the E&M fields of its own emitted light.
- Under the influence of both the undulator magnet and its own synchrotron radiation, the electron beam forms micro-bunches, separated by a distance equal to the wavelength of the emitted radiation.

John Galayda, LCLS

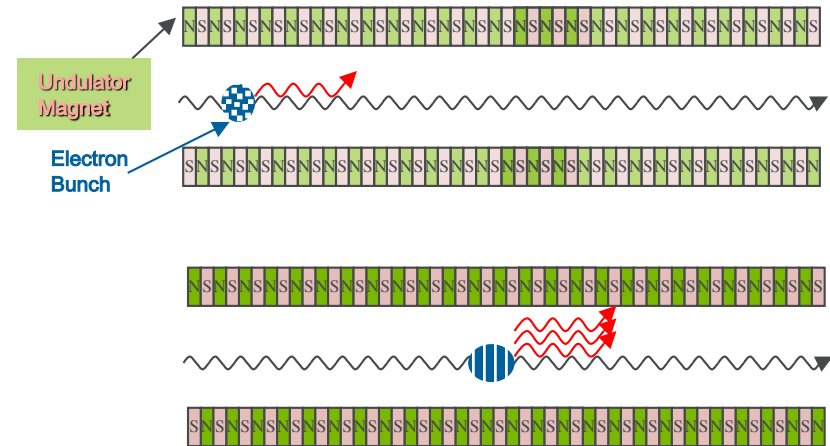

Energy modulation → density modulation



EXPONENTIAL GROWTH OF INTENSITY (THIS IS THE "GAIN" IN THE SYSTEM)

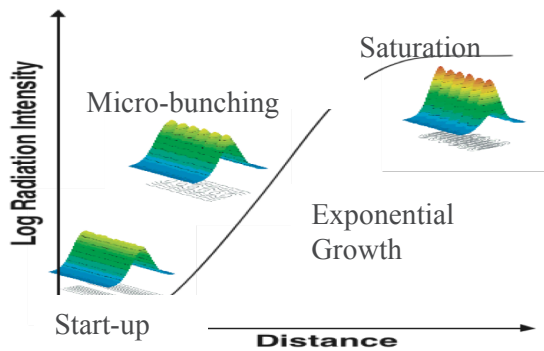

- These micro-bunches begin to radiate as if they were single particles with immense charge.
- The lasing starts up from the random micro-bunching (i.e., shot noise) on the electron beam – this is called: **Self-Amplified Spontaneous Emission (SASE)**
- The process reaches *saturation* when The micro-bunching process has gone as far as it can go.

See Appendix 7 for more details on SASE.

John Galayda, LCLS

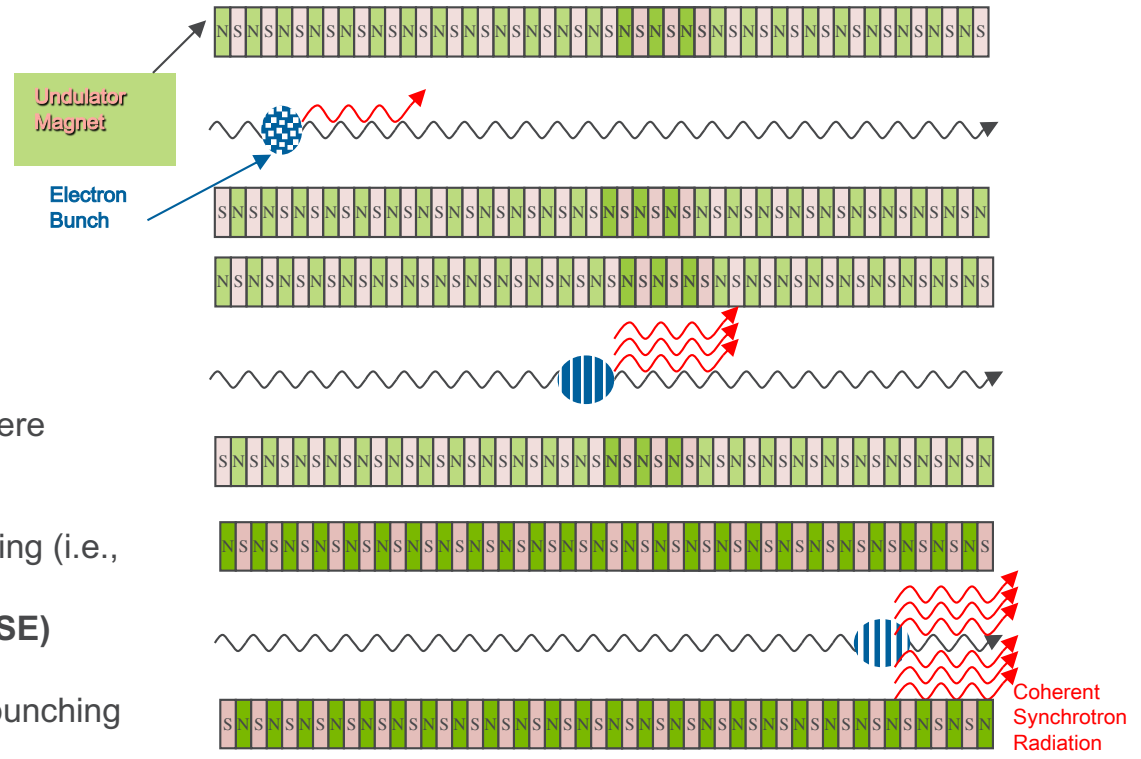

$$Power\ Radiated = \frac{2e^2}{3c^3} \frac{\gamma^4 v^4}{r^2} = \frac{2e^2}{3r^2} \frac{E^4}{m_0^4 c^8}$$

HARD X-RAY FELS IN OPERATION / CONSTRUCTION

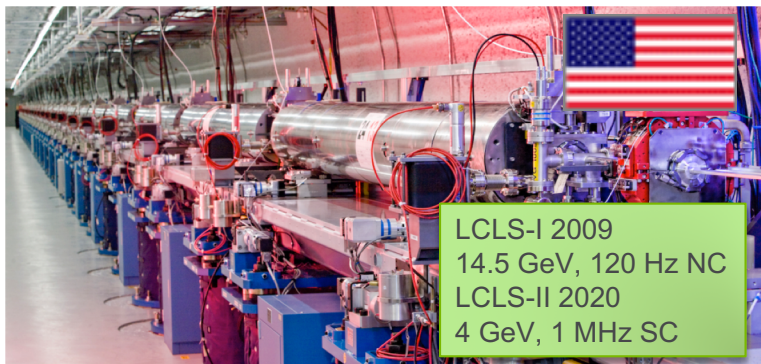

NC = normal conducting LINAC
SC = superconducting LINAC

SUMMARY

- Synchrotron radiation continues to be an important tool for researchers across all scientific and engineering disciplines.
- There is a strong science case for a new generation of sources such as:
 - Low-emittance storage rings
 - X-ray free electron lasers
- Storage rings can produce partially coherent x-ray beams with megahertz repetition rates but with lower peak power.
 - The APS is working to incorporate a low emittance lattice into the proposed upgrade of the facility (APS-U) that will produce beams of high coherence at megahertz rates.
- FELs can provide very short pulses (femtoseconds) of high peak intensity, coherent x-rays but the repetition rate is currently limited to hundreds of hertz.
 - Superconducting radio frequency linacs will increase that to MHz.
- Both LCLS II, APS-U, and the proposed upgrade for the Advanced Light Source at LBNL (ALS-U) will keep US x-ray facilities at the cutting edge to produce world class science in the years to come.

REFERENCES

“Introduction to Synchrotron Radiation” by Giorgio Margaritondo

“Synchrotron Radiation Sources – A Primer” by Herman Winick

“Undulators, Wigglers, and their Applications” Edited by H. Onuki and P. Elleaume

“Elements of Modern X-ray Physics” by Jens Als-Nielsen and Des McMorrow

“Third-Generation Hard X-Ray Synchrotron Radiation Sources: Source Properties, Optics, and Experimental Techniques”, Edited by Dennis M. Mills

“Synchrotron Radiation and Free-Electron Lasers: Principles of Coherent X-Ray Generation”, by Kwang-Je Kim, Zhirong Huang and Ryan Lindberg

“Handbook of Accelerator Physics and Engineering”, Edited by A. Cho and M. Tigner

QUESTIONS?

APPENDIX 1A: RADIATED POWER FROM CHARGES AT RELATIVISTIC VELOCITIES

The classical formula for the radiated power from an accelerated electron is:

$$P = \frac{2e^2}{3c^3} a^2$$

Where P is the power and α the acceleration. For a circular orbit of radius r , in the non-relativistic case, α is just the centripetal acceleration, v^2/r . In the relativistic case:

$$a = \frac{1}{m_o} \frac{dp}{d\tau} = \frac{1}{m_o} \gamma \frac{d\gamma m_o v}{dt} = \gamma^2 \frac{dv}{dt} = \gamma^2 \frac{v^2}{r}$$

Where $\tau = t/\gamma =$ proper time, $\gamma = 1/\sqrt{1-\beta^2} = E/m_o c^2$ and $\beta = v/c$

$$P = \frac{2e^2}{3c^3} \frac{\gamma^4 v^4}{r^2} = \frac{2ce^2}{3r^2} \frac{E^4}{m_o^4 c^8}$$

APPENDIX 1B: DEPENDENCE ON MASS AND ENERGY OF RADIATED POWER

$$P = \frac{2e^2}{3c^3} \frac{\gamma^4 v^4}{r^2} = \frac{2ce^2}{3r^2} \frac{E^4}{m_o^4 c^8}$$

There are two points about this equation for total radiated power:

1. Scales inversely with the mass of the particle to the 4th power (protons radiate considerably less than an e⁻ with the same total energy, E.)
2. Scales with the 4th power of the particle's energy (a 7 GeV storage ring radiates 2400 times more power than a 1 GeV ring with the same radius)

APPENDIX 2: BM SPECTRAL DISTRIBUTION

The spectral/angular distribution of "synchrotron radiation" was worked out by J. Schwinger in 1949. Schwinger found the spectral distribution from an accelerating particle, under the influence of a constant magnetic field, was a smoothly varying function of photon energy and that the spectrum could be parameterized by a critical energy, E_c .

$$E_c = 3hc\gamma^3/4\pi r.$$

Here h is Planck's constant and r the radius of curvature of the trajectory. Note that the **critical energy scales as γ^3** . In practical units, the critical energy can be written as:

$$E_c[\text{keV}] = 2.218 E^3[\text{GeV}] / \rho[\text{m}] = 0.06651 B[\text{kG}] E^2[\text{GeV}]$$

At the APS the bending magnets have a field strength of 5.99 kilogauss and the ring operates at $E = 7 \text{ GeV}$. The critical energy of the radiation emitted from the BM is:

$$E_c[\text{keV}] = 0.06651 B[\text{kG}] E^2[\text{GeV}]$$

or

$$E_c = 0.06651(5.990)(7^2) = \underline{19.5 \text{ keV}} \text{ or } \underline{0.64 \text{ \AA}}.$$

APPENDIX 3: WHERE DID “K” COME FROM?

$$F_x = ma_x = \gamma m_0 \dot{v}_x = e\vec{v} \times \vec{B} = ecB_0 \sin\left(\frac{2\pi z}{\lambda_{TD}}\right)$$

$$\dot{v}_x = \frac{ecB_0}{\gamma m_0} \sin\left(\frac{2\pi z}{\lambda_{TD}}\right) \quad z = ct$$

$$v_x = -\frac{ecB_0}{\gamma m_0} \frac{\lambda_{TD}}{2\pi c} \cos\left(\frac{2\pi ct}{\lambda_{TD}}\right) = -\frac{eB_0}{\gamma m_0} \frac{\lambda_{TD}}{2\pi} \cos\left(\frac{2\pi ct}{\lambda_{TD}}\right)$$

$$x = \frac{eB_0}{\gamma m_0 c} \left[\frac{\lambda_{TD}}{2\pi}\right]^2 \sin\left(\frac{2\pi ct}{\lambda_{TD}}\right) = \left[\frac{eB_0}{m_0} \frac{\lambda_{TD}}{2\pi c}\right] \frac{1}{\gamma} \left[\frac{\lambda_{TD}}{2\pi}\right] \sin\left(\frac{2\pi z}{\lambda_{TD}}\right) = K \frac{1}{\gamma} \left[\frac{\lambda_{TD}}{2\pi}\right] \sin\left(\frac{2\pi z}{\lambda_{TD}}\right)$$

$$x_{\max} = K \frac{1}{\gamma} \left[\frac{\lambda_{TD}}{2\pi}\right] \quad \text{and} \quad \left[\frac{dx}{dz}\right]_{\max} = \frac{K}{\gamma} \quad \text{where} \quad K = \left[\frac{eB_0}{2\pi} \frac{\lambda_{TD}}{m_0 c}\right]$$

Equation of motion for a relativistic charged particle in a magnetic field

Magnetic field in y-direction and electron traveling in z-direction

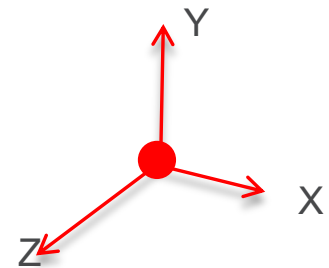

APPENDIX 4: HOW DO YOU GET 1 Å X-RAYS FROM A 3 CM PERIOD MAGNETIC FIELD?

Where does the $1/\gamma^2$ come from in the equation: $\lambda_n^{\text{x-ray}} = (\lambda_{\text{ID}}/2\gamma^2 n)(1 + K^2/2)$?

1) Consider the electron in its rest frame:

- It does not see a static magnetic field from the undulator, but rather a time-varying B-field and associated E-field (due to the relativistic transformation of the magnetic field of the device).
- The period of the E and B field are **Lorentz contracted** so that: $\lambda_{\text{e-frame}} = \lambda_{\text{ID}} / \gamma$ and so the electron oscillates (and hence radiates) with that same period driven by the EM fields.

2) Back in the lab frame:

- Due to the fact that the electron is traveling towards us, the radiation emitted by the electron is Doppler shifted to higher frequencies (shorter wavelengths). The **relativistic Doppler shift** goes as $\sqrt{1-\beta} / \sqrt{1+\beta} \approx 1/2\gamma$, and so the wavelength observed in the lab is:

$$\lambda_{\text{lab}} \approx (\lambda_{\text{ID}}/\gamma)(1/2\gamma) = (\lambda_{\text{ID}}/2\gamma^2)$$

APPENDIX 5: CALCULATING X-RAY BRIGHTNESS

APS Electron Beam Parameters

APS operates with $\varepsilon_H = 3 \times 10^{-9}$ m-rad and a coupling (ratio of vertical emittance to horizontal emittance) of 0.9% , therefore

$$\varepsilon_V = 0.025 \times 10^{-9} \text{ m-rad.}$$

The particle beam source size and divergence at the locations of the IDs are:

$$\begin{aligned}\sigma_H &= 270 \text{ microns} \\ \sigma'_H &= 11 \text{ microradians} \\ \sigma_V &= 9 \text{ microns} \\ \sigma'_V &= 3 \text{ microradians}\end{aligned}$$

APS Undulator X-ray Beam Parameters

APS Undulator A has a length of 2.4 meters. For 1 Å radiation the natural opening angle is:

$$\begin{aligned}\sigma'_{\text{x-ray}} &= 1/\gamma (1/N)^{1/2} \\ &= [\lambda/2L]^{1/2} = 4.5 \times 10^{-6} \text{ rad}\end{aligned}$$

The corresponding source size of the radiation is:

$$\sigma_{\text{x-ray}} = [\lambda L/8\pi^2]^{1/2} = 1.7 \text{ microns.}$$

For source size $\Sigma = [\sigma_{\text{x-ray}}^2 + \sigma_{\text{electron}}^2]^{1/2}$ and source divergence $\Sigma' = [\sigma'_{\text{x-ray}}^2 + \sigma'_{\text{electron}}^2]^{1/2}$

$$\mathcal{B} = \text{Flux}/4\pi^2 \Sigma_H \Sigma_V \Sigma_H' \Sigma_V'$$

APPENDIX 6: TIME STRUCTURE OF THE RADIATION

- Because the electrons are radiating x-rays, they are constantly losing energy.
- To restore the energy loss on each revolution, radio-frequency (RF) cavities are installed in the storage ring to replenish the radiative energy losses.
- Particles are grouped together by the action of the radio-frequency (RF) cavities into bunches. At APS:
 - typically about 100 psec FWHM (about 3 cm in length)
 - 1104 m circumference (3.68 microsecond period)
 - there are 1296 evenly spaced “RF buckets” (stable orbit positions) around the ring
 - minimum spacing is 2.8 nsec between bunches (determined by the RF frequency- 352MHz)
- Details of the time structure depends on the fill pattern, i.e. which RF buckets have electrons in them.

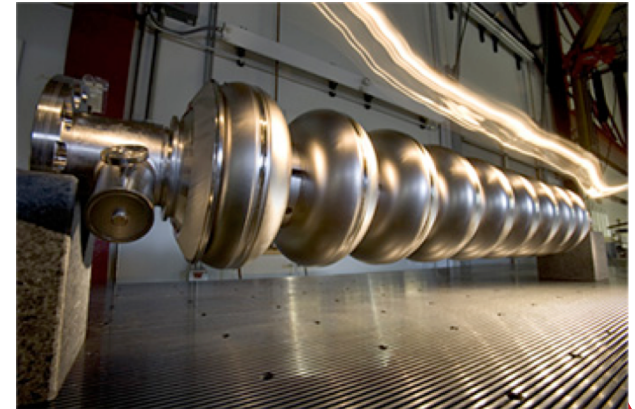
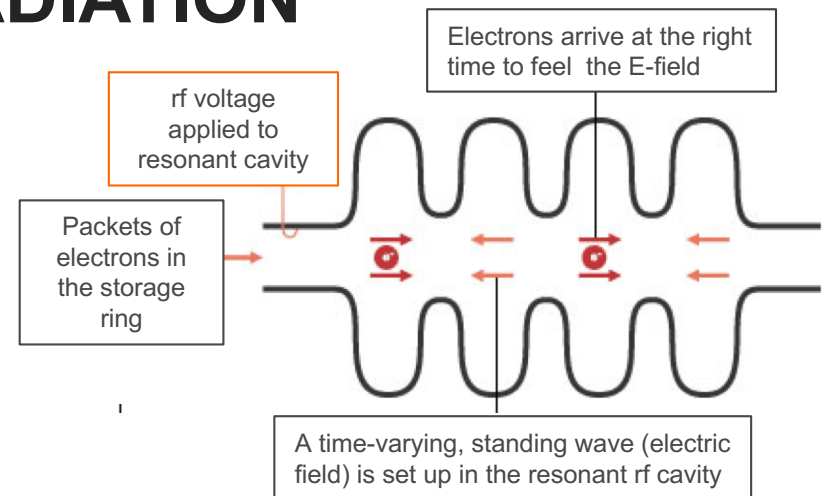

APPENDIX 6: APS FILLING PATTERNS

Fill patterns

in FY17

24-bunch (65%): 80 ps (FWHM), 4.25 mA



Hybrid-singlet (15%): 120 ps (FWHM), 16 mA



324-bunch (20%): 50 ps (FWHM), 0.3 mA



- The APS has a 1104 m circumference (3.68 microsec period).
- There are 1296 evenly spaced “RF buckets”(stable orbit positions) around the ring that electrons could be stored in.
- This would correspond to a spacing of 2.8 nsec between bunches.
- The time structure is determined by which of the buckets are filled with electrons.
- 24 equally spaced bunches
 - compromise between quasi-continuous source and pulsed source
- 1 + 7x8 (hybrid-singlet mode)
 - timing experiments
- 324 equally spaced bunches
 - approximates a continuous source

APPENDIX 7: THE SASE PROCESS

- The lasing starts up from the random micro-bunching (i.e., shot noise) on the electron beam instead of being coherently produced by an input “seed” source.

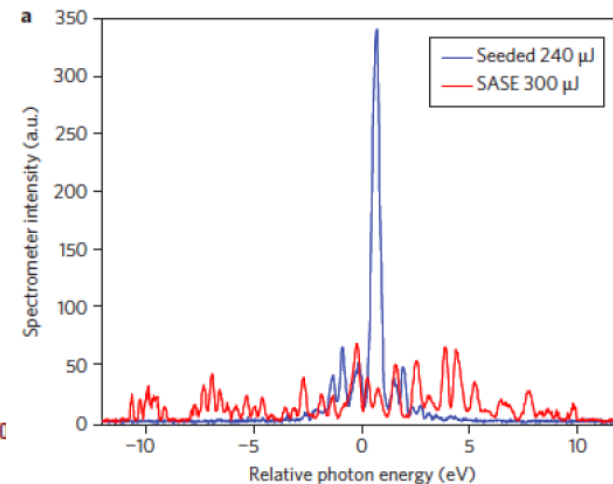
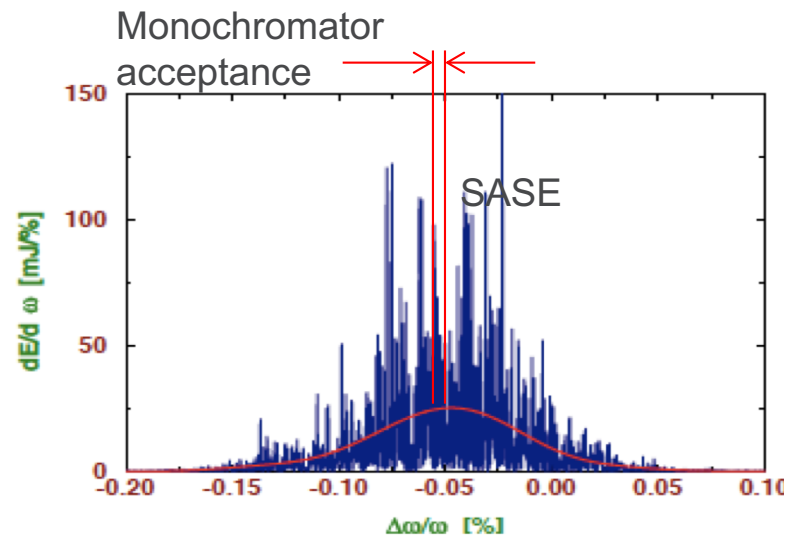
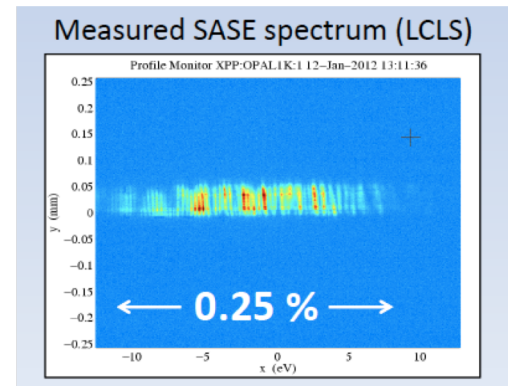

One possible “seeding” geometry is to use a diamond crystal to select the wavelength of interest to amplify.

